

| REVISIONS | | | | |
|-----------|-----|-------------|------|----------|
| ZONE | REV | DESCRIPTION | DATE | APPROVED |
| | | | | |

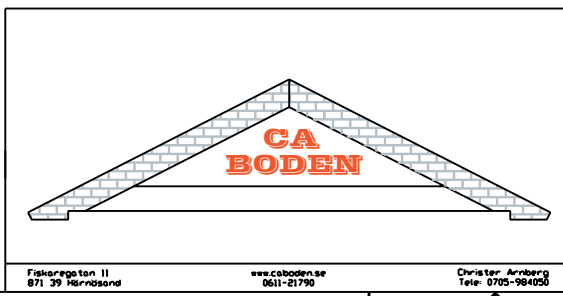
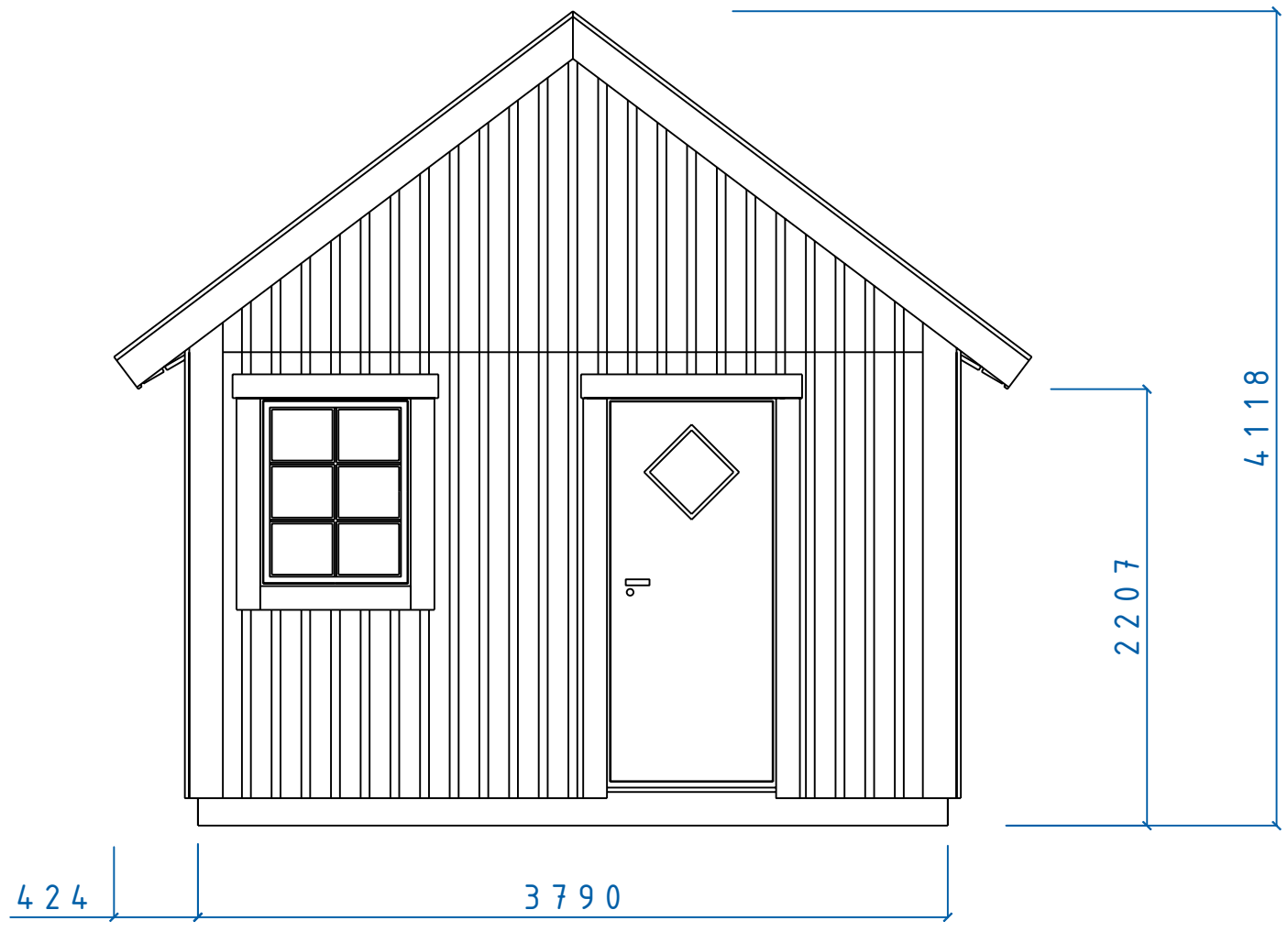

| | | | |
|------------------------|-------------------------|---------|-------|
| MAXI SERIE | | | |
| FASAD GAVEL TAK 37° | | | |
| FÖNSTER 8x10 DÖRR 9x20 | | | |
| SIZE | DATE | DWG NO. | REV |
| 060207 | 05100497 | | |
| SCALE | Designed by: SMÄLÄNNING | | SHEET |

Fiskaregatan 11
871 39 Värmdö

www.caboden.se
061-21790

Christer Arnborg
Tele: 0705-984050

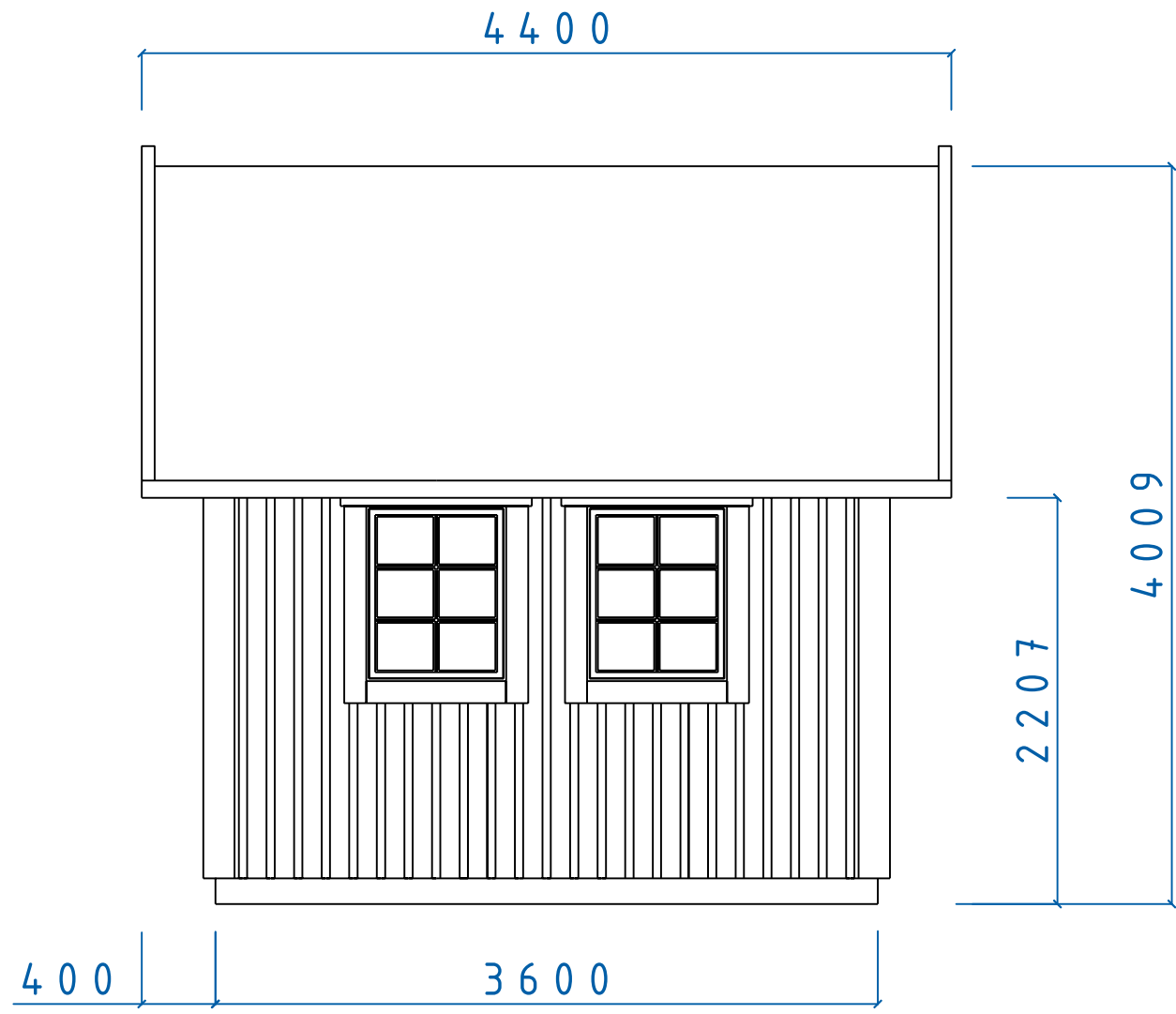

| REVISIONS | | | | |
|-----------|-----|-------------|------|----------|
| ZONE | REV | DESCRIPTION | DATE | APPROVED |
| | | | | |

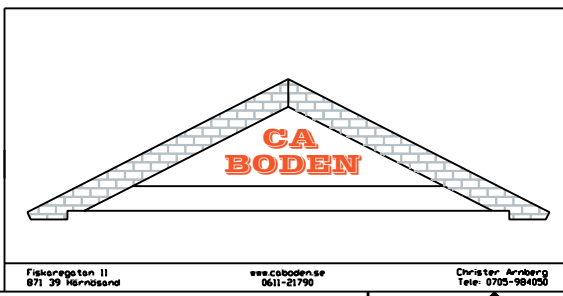

| | | | | |
|-----------------------------|-------------------------|----------|-------|--|
| MAXI SERIE | | | | |
| ALNÖ FASAD F8x10 TAK 37° | | | | |
| SIZE | DATE | DWG NO. | REV | |
| | 060309 | 05100678 | | |
| SCALE | Designed by: SMÅLÄNNING | | SHEET | |

| REVISIONS | | | | |
|-----------|-----|-------------|------|----------|
| ZONE | REV | DESCRIPTION | DATE | APPROVED |
| | | | | |

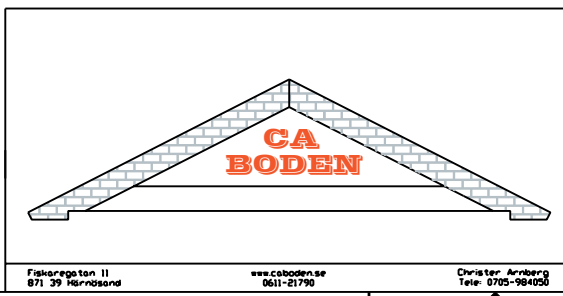
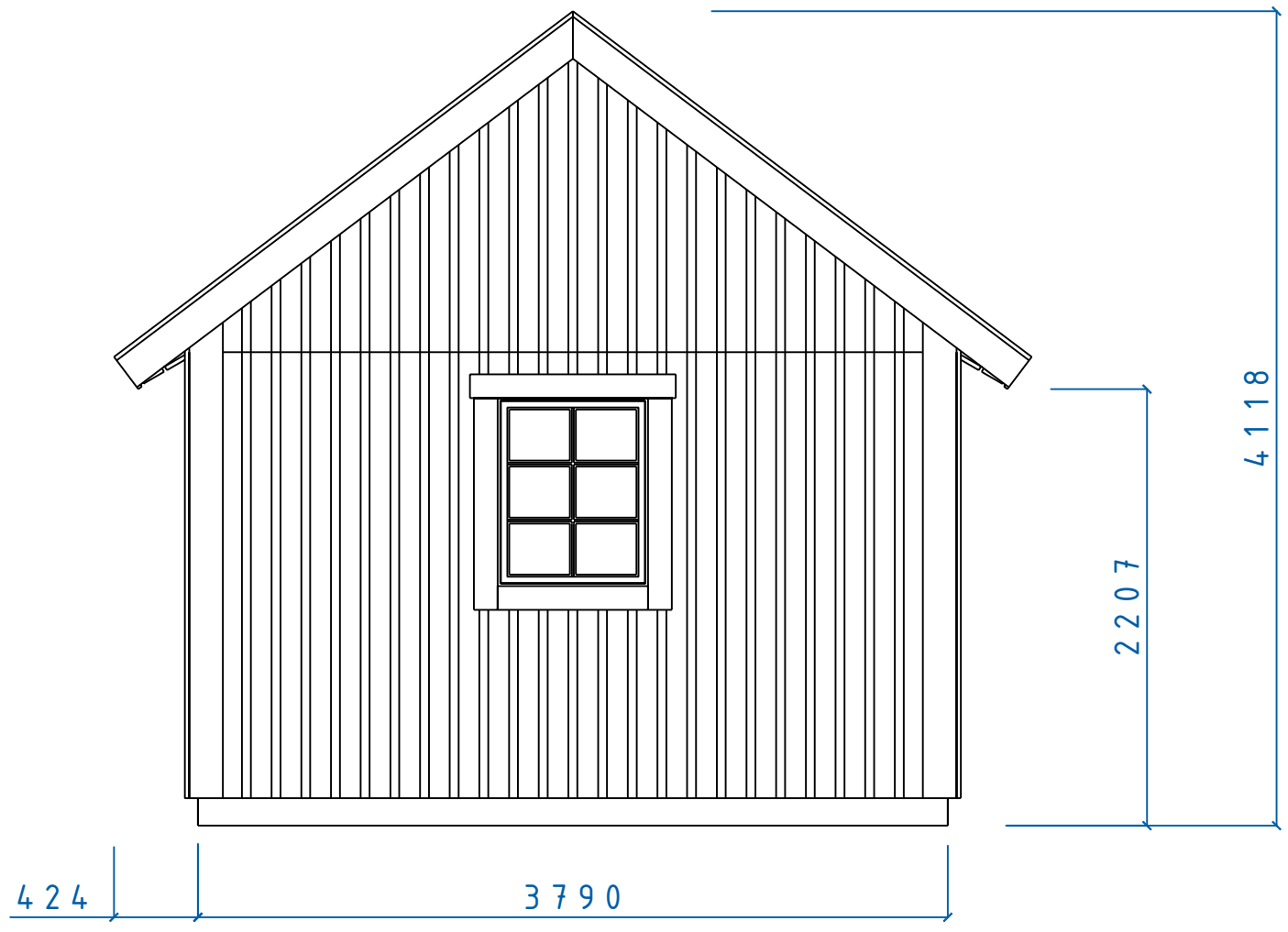

| | | | |
|----------------|-------------------------|----------|-------|
| MAXI SERIE | | | |
| FASAD GAVEL | | | |
| F 8x10 TAK 37° | | | |
| SIZE | DATE | DWG NO. | REV |
| 060207 | | 05100496 | |
| SCALE | Designed by: SMÅLÄNNING | | SHEET |

Fiskaregatan 11
871 39 Fårösand

www.caboden.se
0611-21790

Christer Arnborg
Tele: 0705-984050

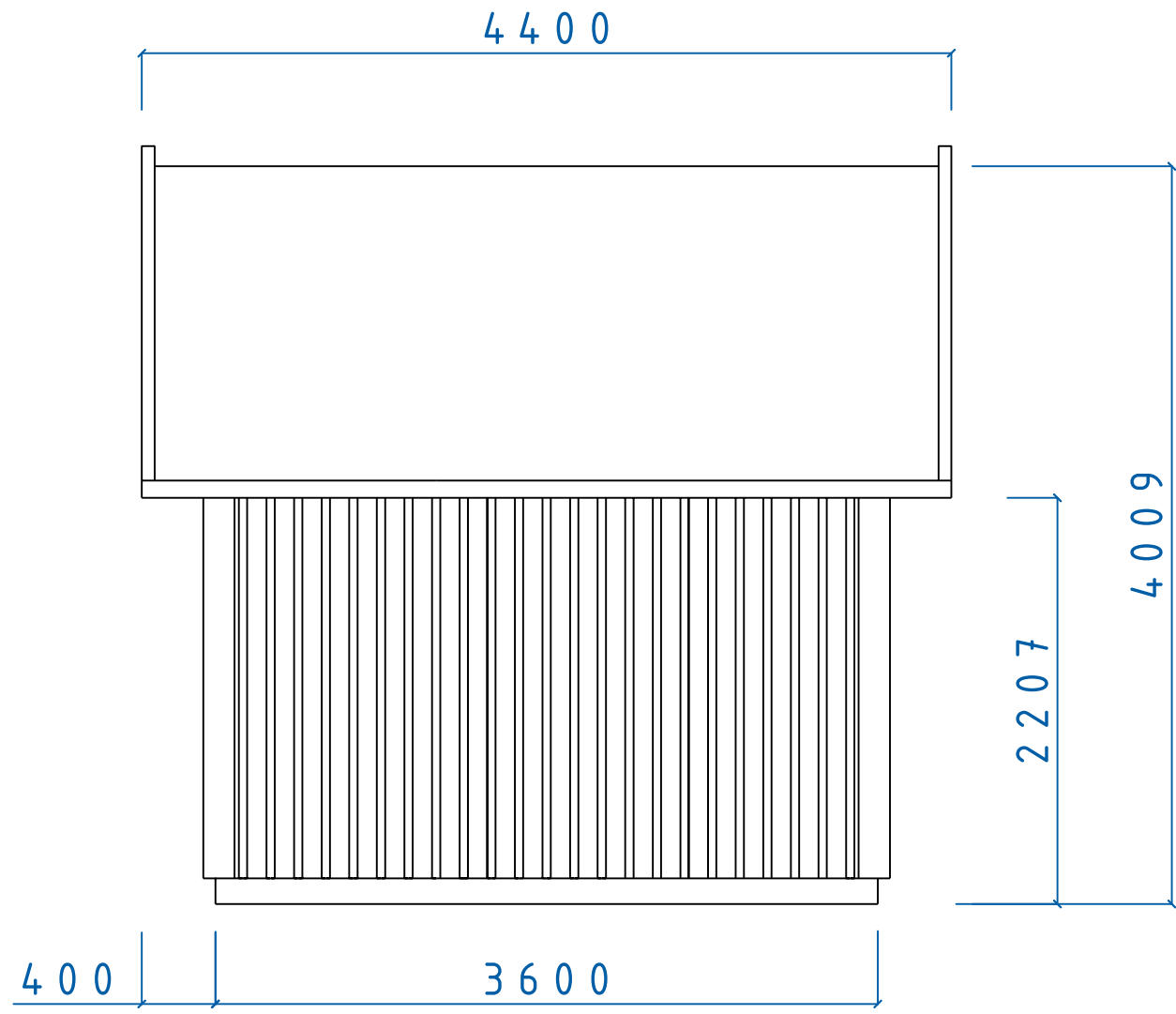

| REVISIONS | | | | |
|-----------|-----|-------------|------|----------|
| ZONE | REV | DESCRIPTION | DATE | APPROVED |
| | | | | |

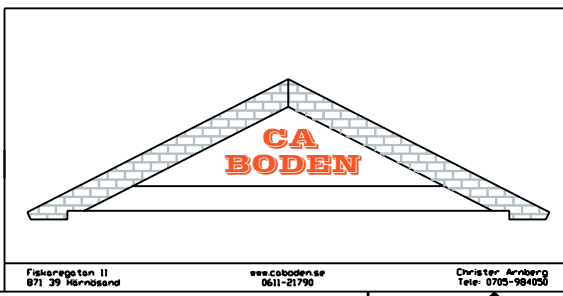

| | | | | |
|-----------------------|-------------------------|----------|-------|--|
| MAXI SERIE | | | | |
| ALNÖ FASAD TAK 37° | | | | |
| SIZE | DATE | DWG NO. | REV | |
| | 060309 | 05100675 | | |
| SCALE | Designed by: SMÅLÄNNING | | SHEET | |

| REVISIONS | | | | |
|-----------|-----|-------------|------|----------|
| ZONE | REV | DESCRIPTION | DATE | APPROVED |

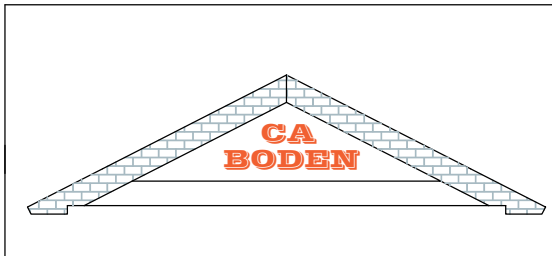
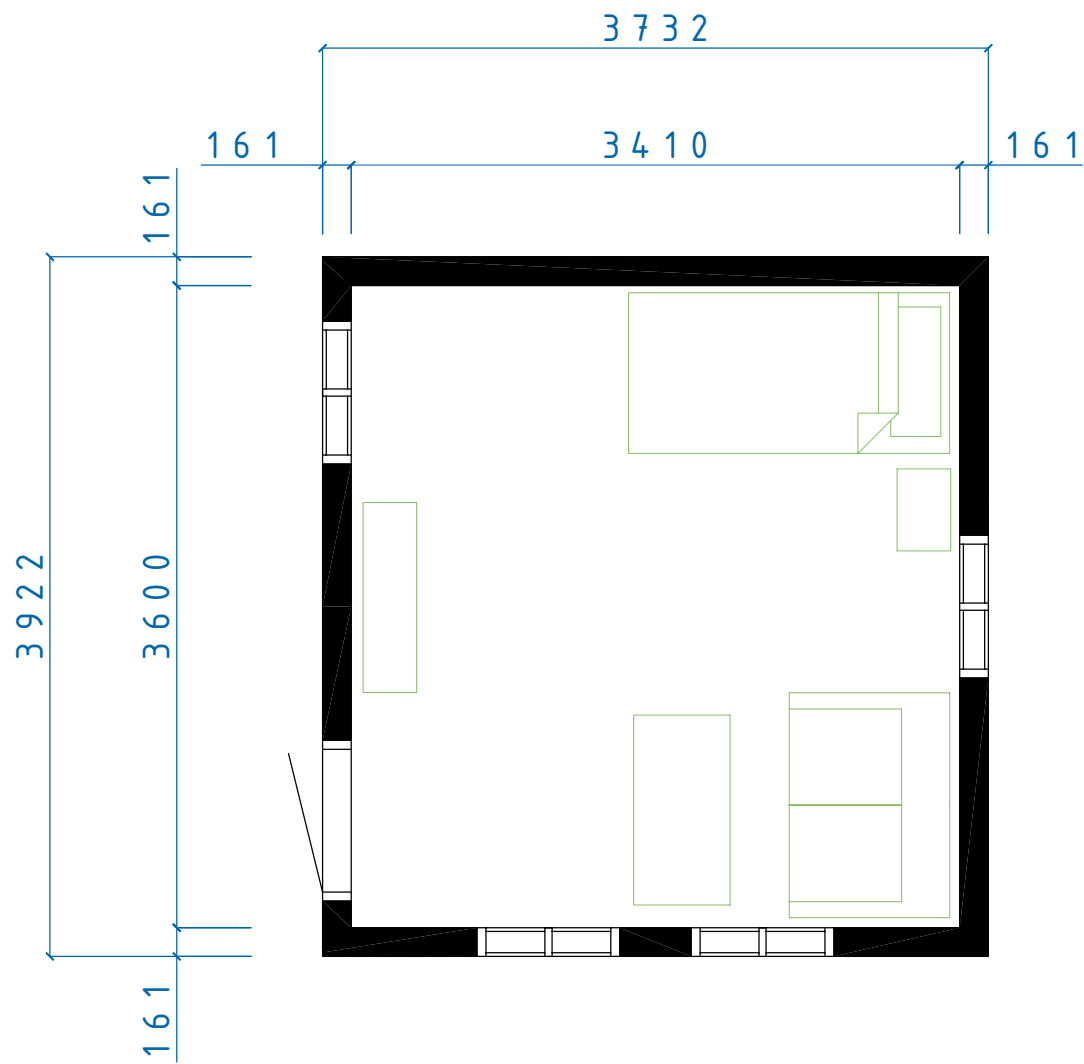

ALNÖ MAXI SERIEN

ALNÖ
PLAN

| | | | |
|------|--------|----------|-----|
| SIZE | DATE | DWG NO. | REV |
| | 060307 | 05100661 | |

Fiskaregatan 11
871 39 Hårnäsönd

www.cabodense
0611-21790

Christer Arnberg
Tele: 0705-984050

| | | |
|-------|-------------------------|-------|
| SCALE | Designed by: SMÅLÄNNING | SHEET |
|-------|-------------------------|-------|

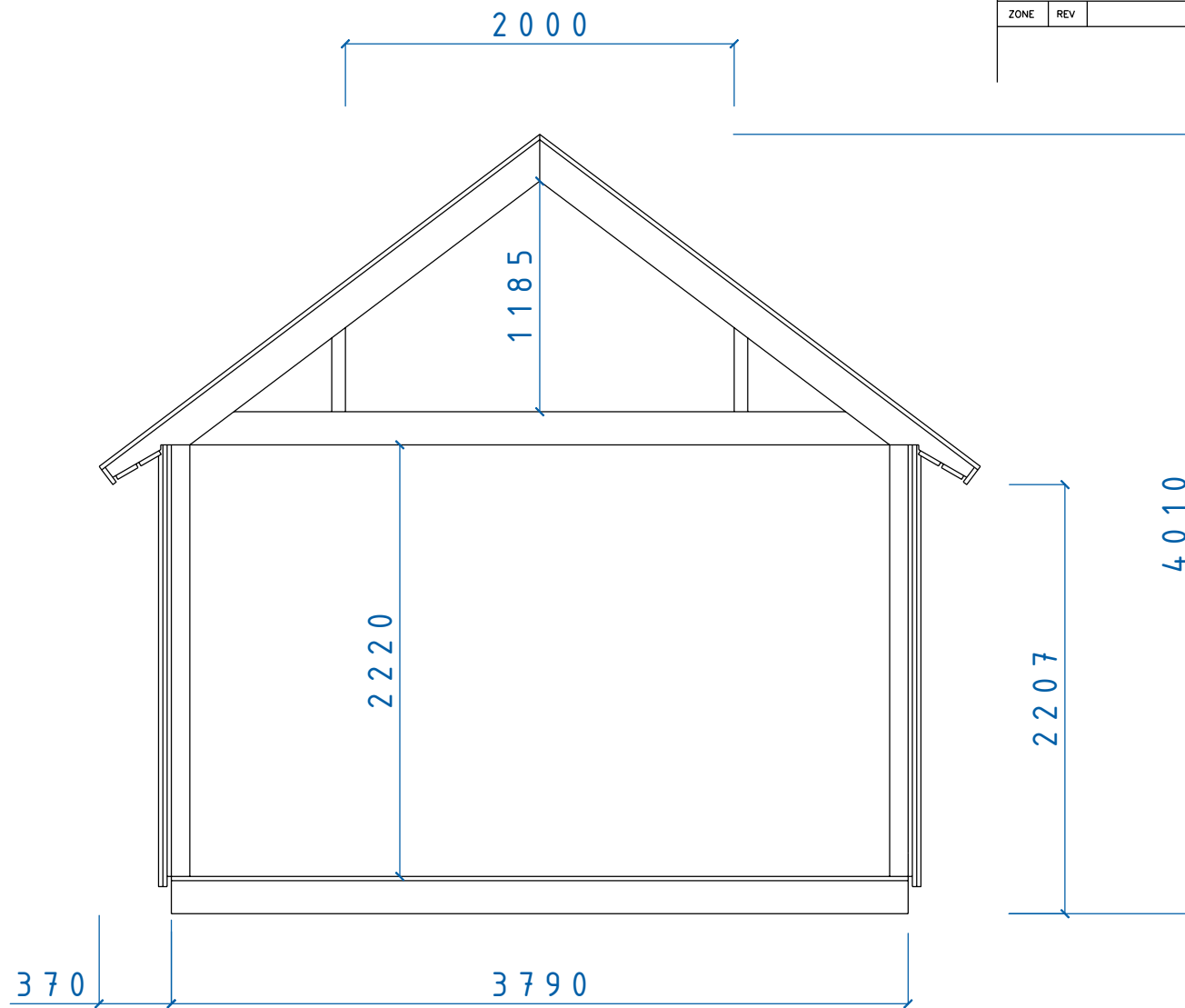

| REVISIONS | | | | |
|-----------|-----|-------------|------|----------|
| ZONE | REV | DESCRIPTION | DATE | APPROVED |
| | | | | |

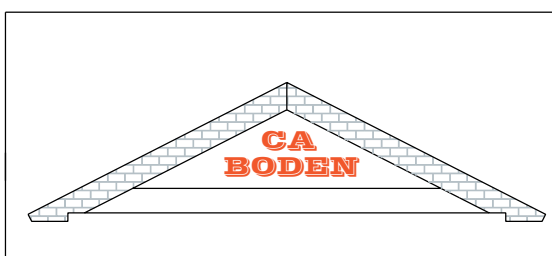

MAXI SERIE
 SEKTION MAXI SERIEN
 Tak 37° Sovloft

| | | | |
|------|--------|----------|-----|
| SIZE | DATE | DWG NO. | REV |
| | 060204 | 05100449 | |