

REVISIONS				
ZONE	REV	DESCRIPTION	DATE	APPROVED

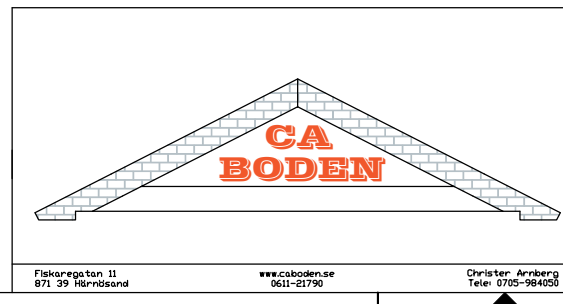

MINI SERIE				
BRÄNNÖ FASAD SIDA				
F8x8 D8x19 TAK 30°				
SIZE	DATE	DWG NO.	REV	
	060402	05100759		
SCALE	Designed by: SMÅLÄNNING		SHEET	

REVISIONS				
ZONE	REV	DESCRIPTION	DATE	APPROVED

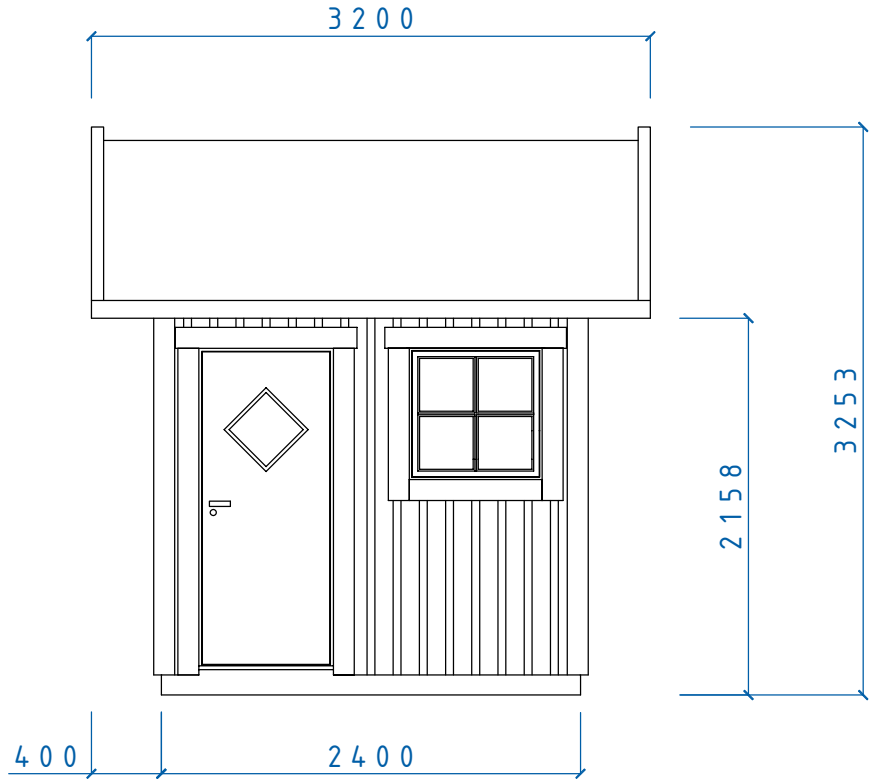
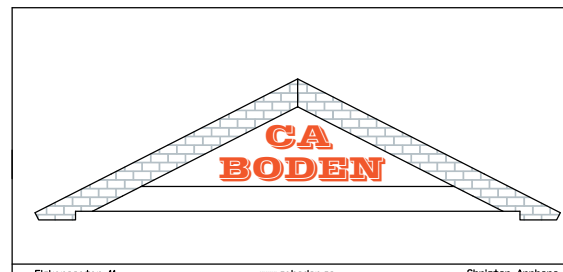
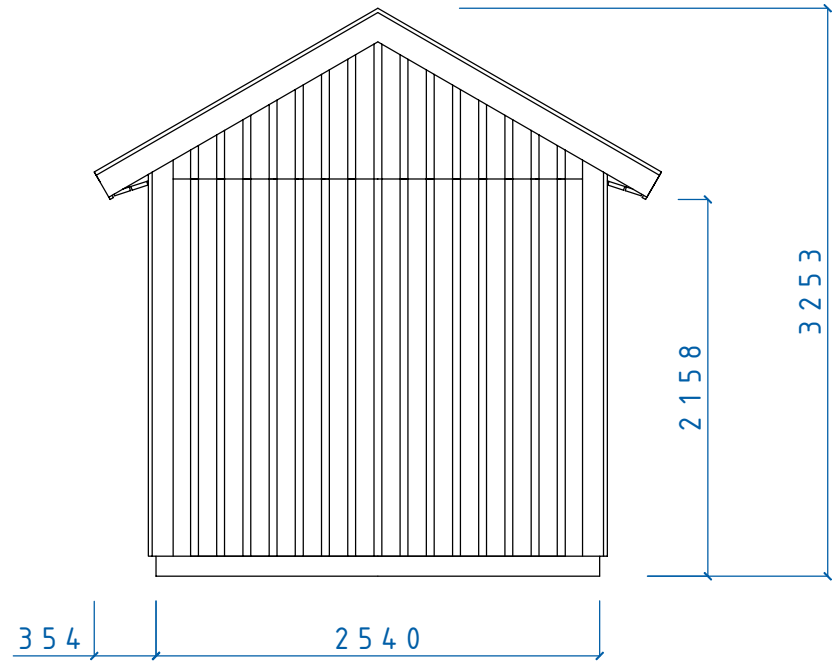

MINI SERIE				
FASAD GAVEL				
TAK 30°				
SIZE	DATE	DWG NO.	REV	
	060328	05100706		
SCALE	Designed by: SMÅLÄNNING		SHEET	

REVISIONS				
ZONE	REV	DESCRIPTION	DATE	APPROVED

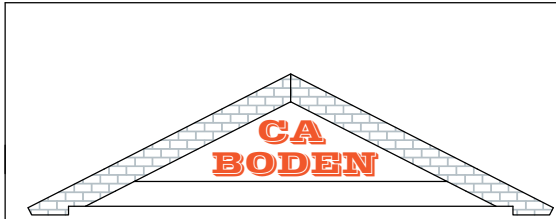
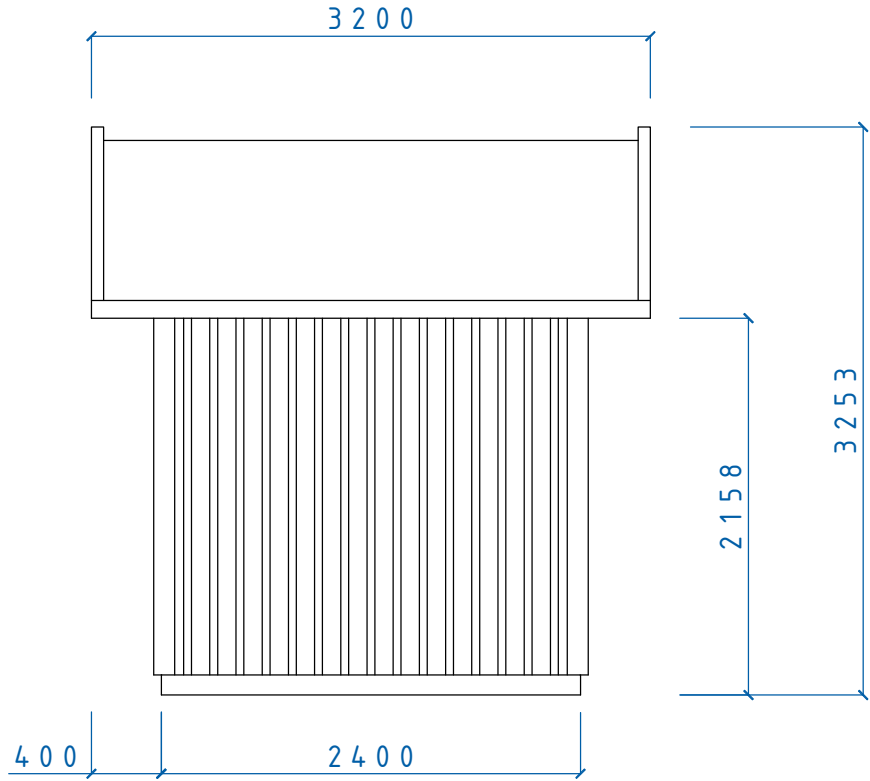

MINI SERIE
 BRÄNNÖ FASAD SIDA
 TAK 30°

SIZE	DATE	DWG NO.	REV
	060328	05100707	

REVISIONS				
ZONE	REV	DESCRIPTION	DATE	APPROVED

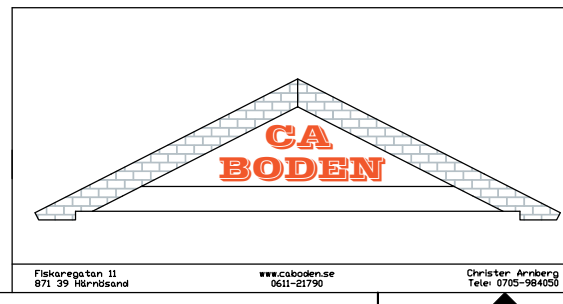
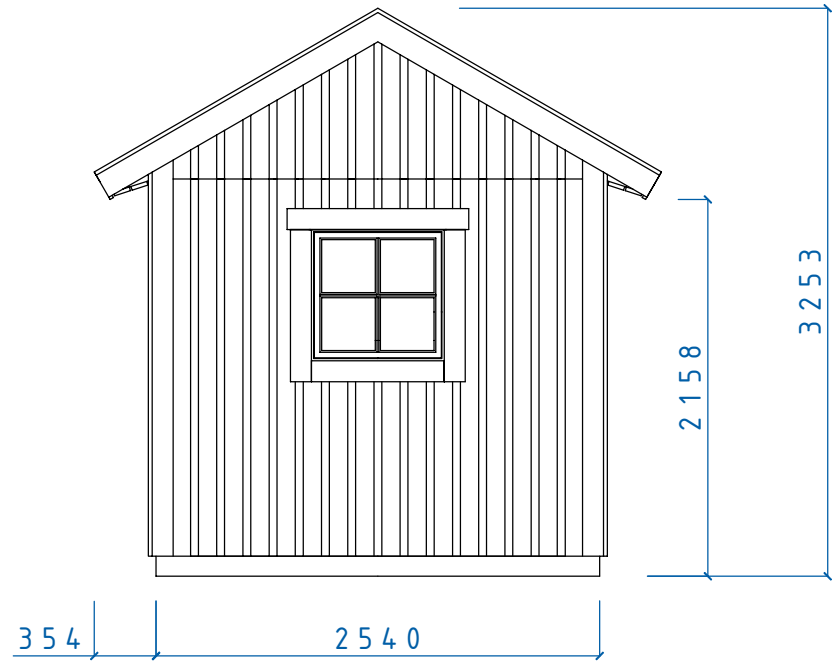

MINI SERIE				
FASAD GAVEL				
F 8x8 TAK 30°				
SIZE	DATE	DWG NO.	REV	
060329	05100709			
SCALE	Designed by: SMÅLÄNNING		SHEET	

REVISIONS				
ZONE	REV	DESCRIPTION	DATE	APPROVED

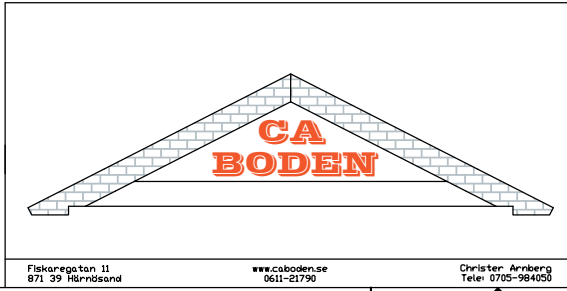
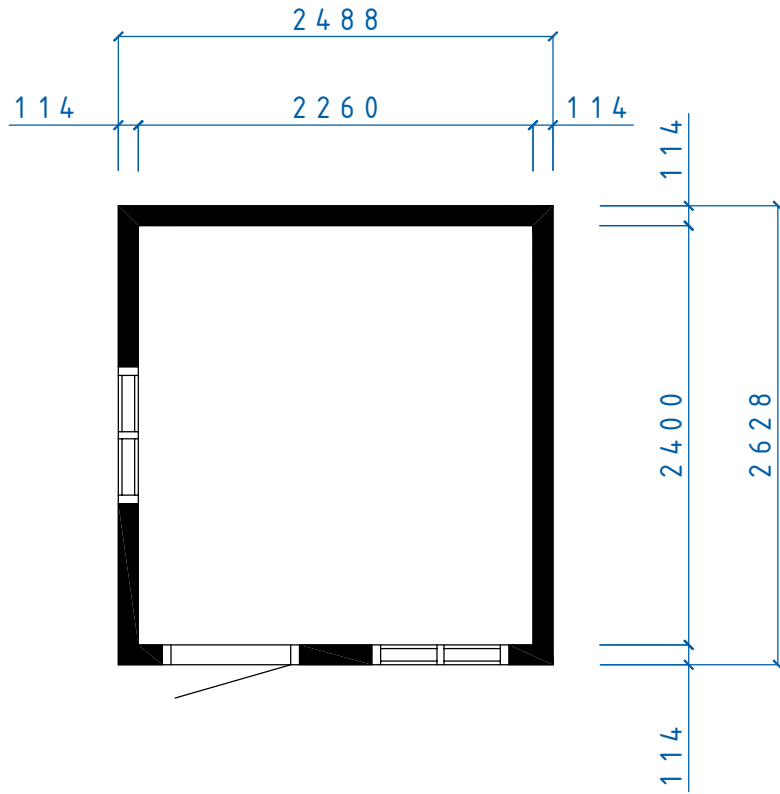

MINI SERIE			
BRÄNNÖ PLAN			
SIZE	DATE	DWG NO.	REV
	060402	05100758	
SCALE	Designed by: SMÅLÄNNING		SHEET

Fiskaregatan 11
871 39 Härnösand

www.cabodense
0611-21790

Christer Arnberg
Tele: 0705-984050

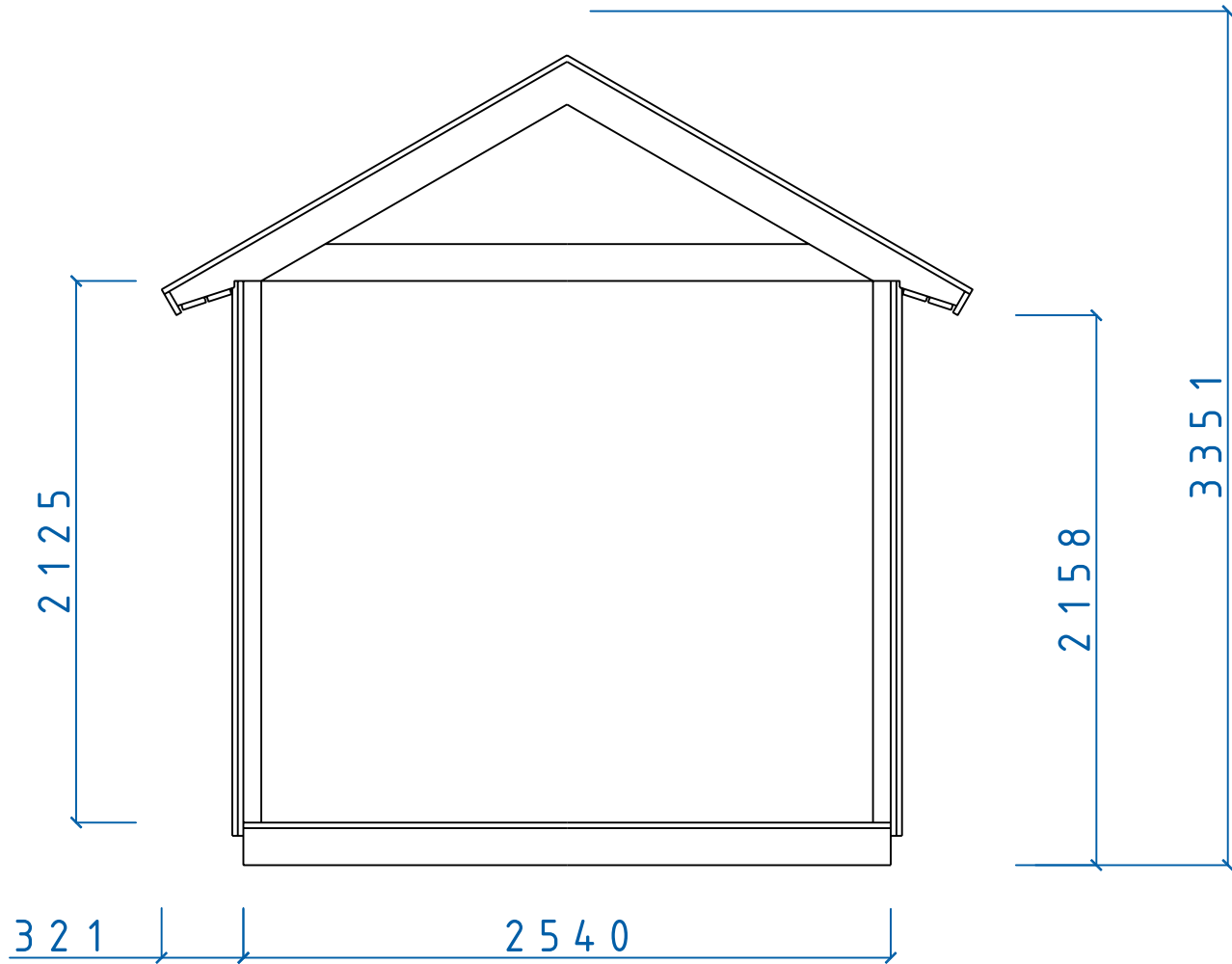

REVISIONS				
ZONE	REV	DESCRIPTION	DATE	APPROVED

		MINI SERIE		
		MINI SEKTION		
SIZE	DATE	DWG NO.	REV	
	060329	05100726		
Fiskaregatan 11 871 39 Rörörsåsa		www.caboden.se 0611-21790	Christer Arnborg Tele: 0705-984050	
SCALE	Designed by: SMÅLÄNNING		SHEET	