

REVISIONS				
ZONE	REV	DESCRIPTION	DATE	APPROVED

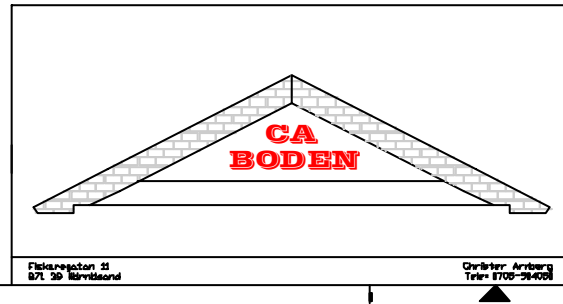

ÄNGA				
ÄNGA VERANDA FASAD FÖNSTERSIDA				
SIZE	DATE	DWG NO.	REV	
	050206	05100237		
Fiskarsgatan 21 871 36 Herråkers		Gårdsbyr Arnborg Tele: 070-36408		SCALE
		Designed by: SMALANING		SHEET

REVISIONS				
ZONE	REV	DESCRIPTION	DATE	APPROVED

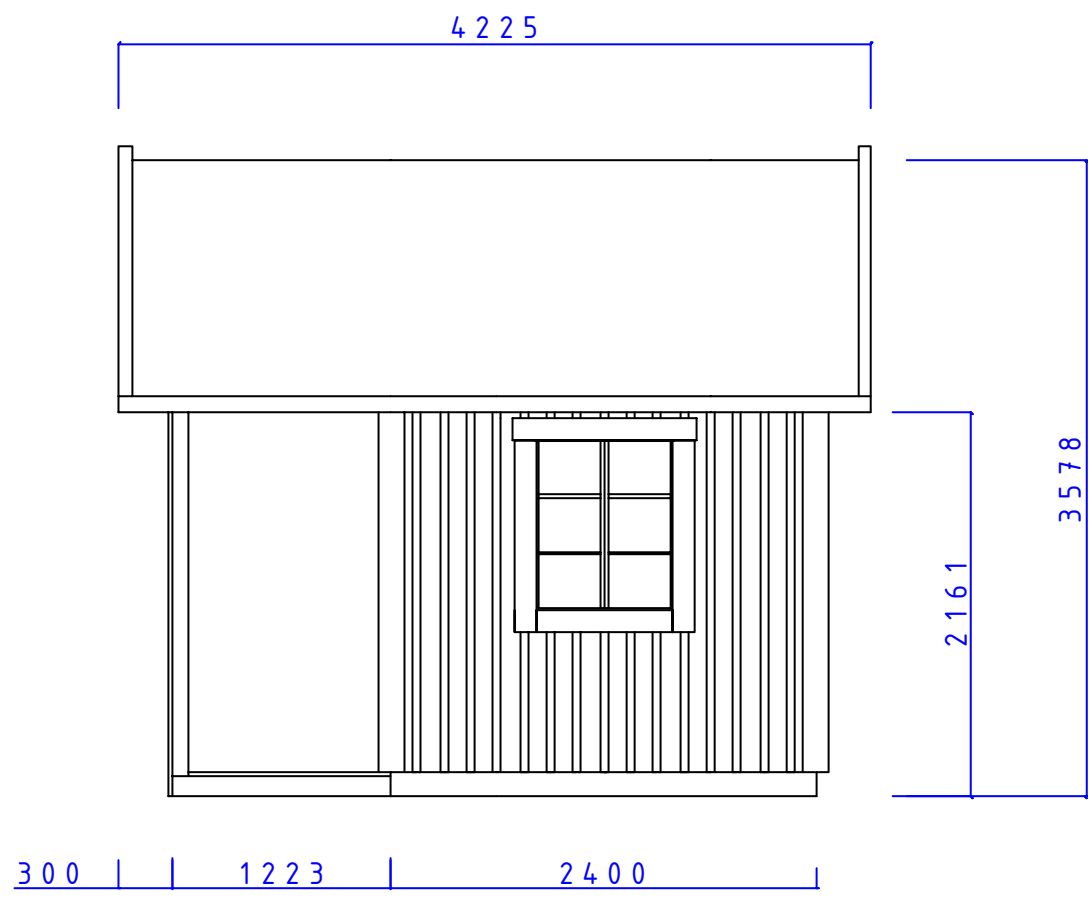
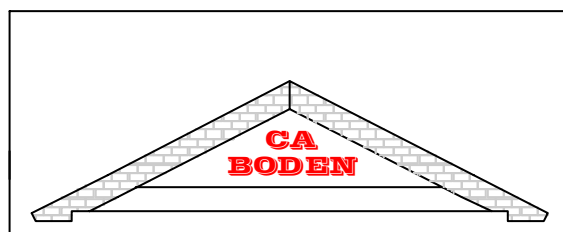
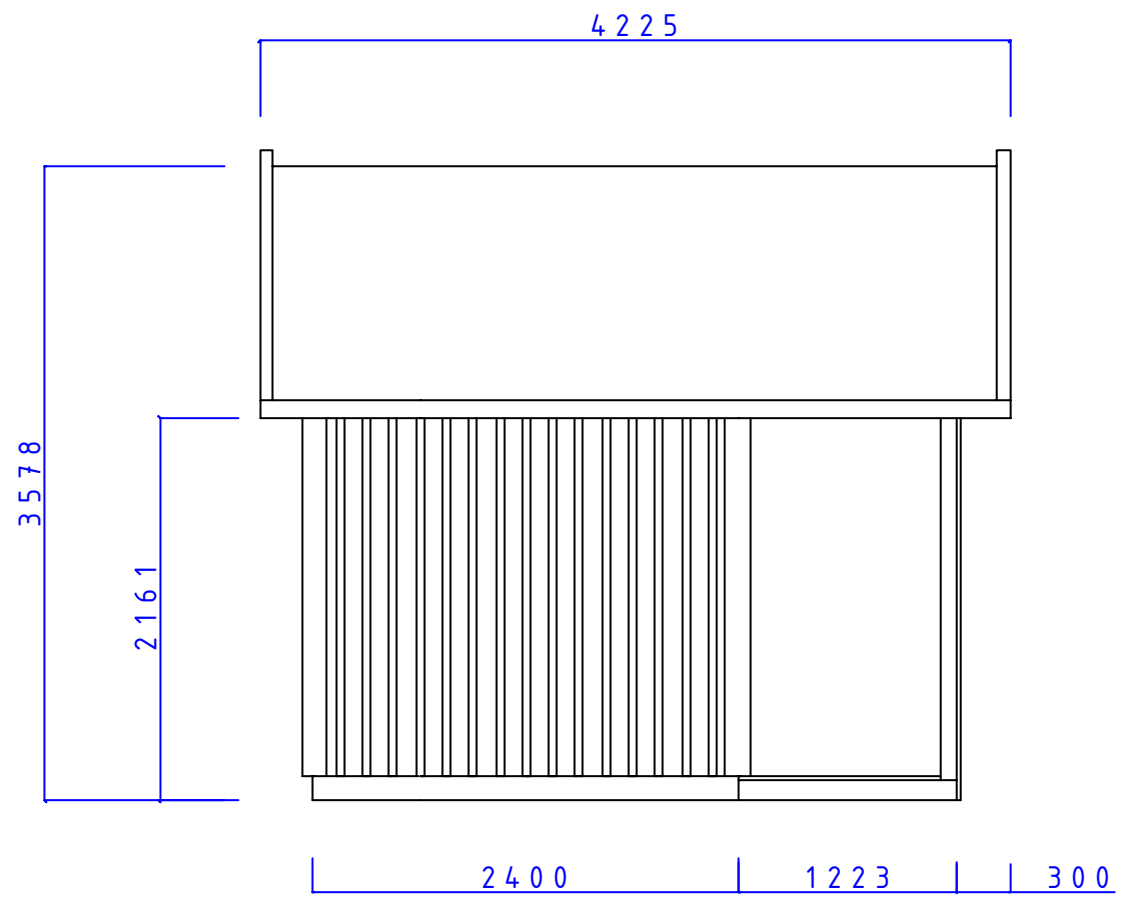

ÄNGA			
ÄNGA VERANDA FASAD SIDA			
SIZE	DATE	DWG NO.	REV
	050206	05100238	

REVISIONS				
ZONE	REV	DESCRIPTION	DATE	APPROVED

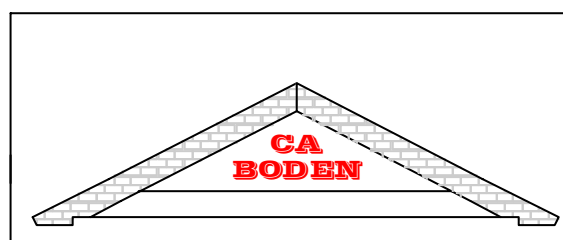
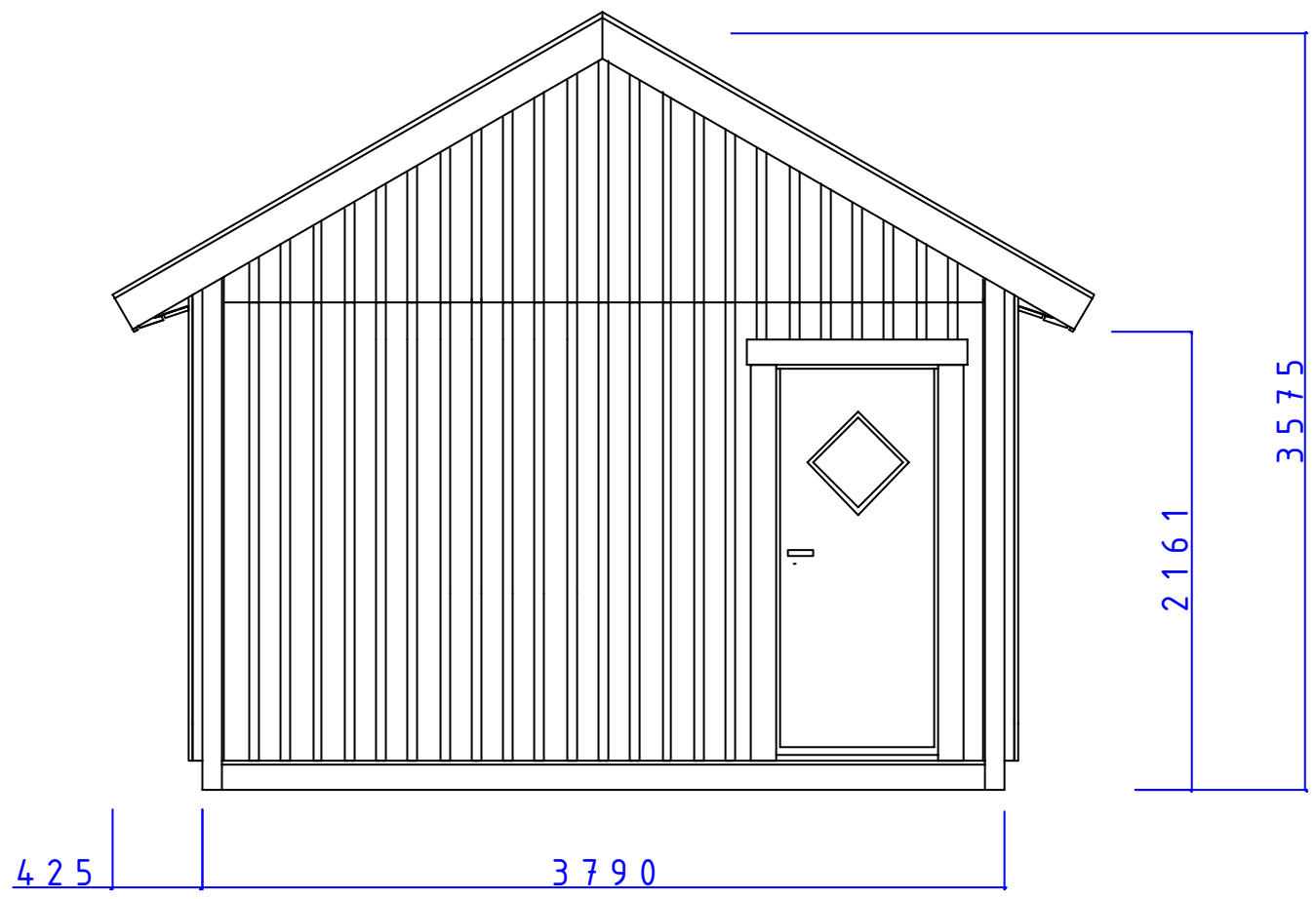

ÄNGA			
ÄNGA DÖRRGAVEL VERANDA			
SIZE	DATE	DWC NO.	REV
	050206	05100239	
SCALE	Designed by: SMALANNIC		SHEET

REVISIONS				
ZDNE	REV	DESCRIPTION	DATE	APPROVED

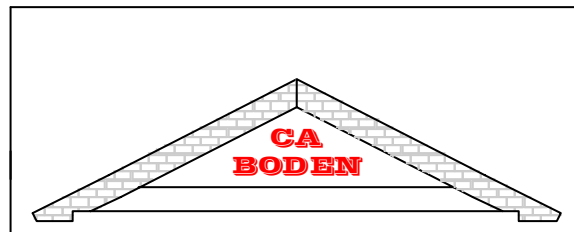
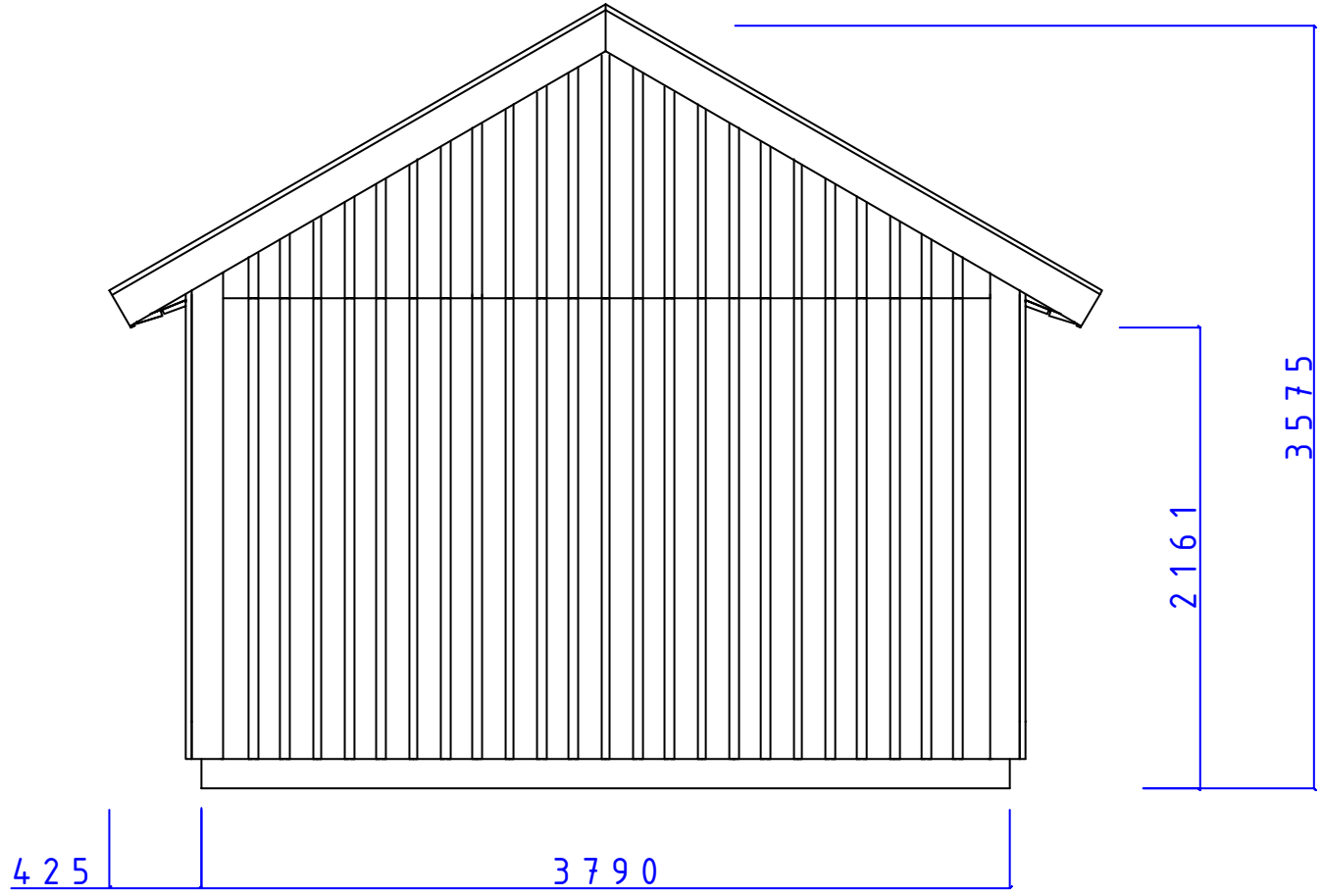

MAXI SERIE			
FASAD GAVEL			
SIZE	DATE	DWG NO.	REV
	050203	05100210	

REVISIONS				
ZONE	REV	DESCRIPTION	DATE	APPROVED

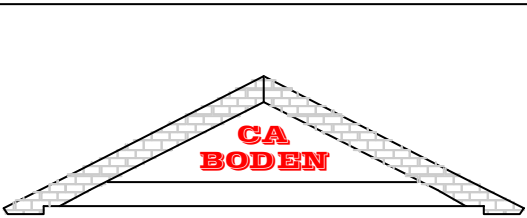
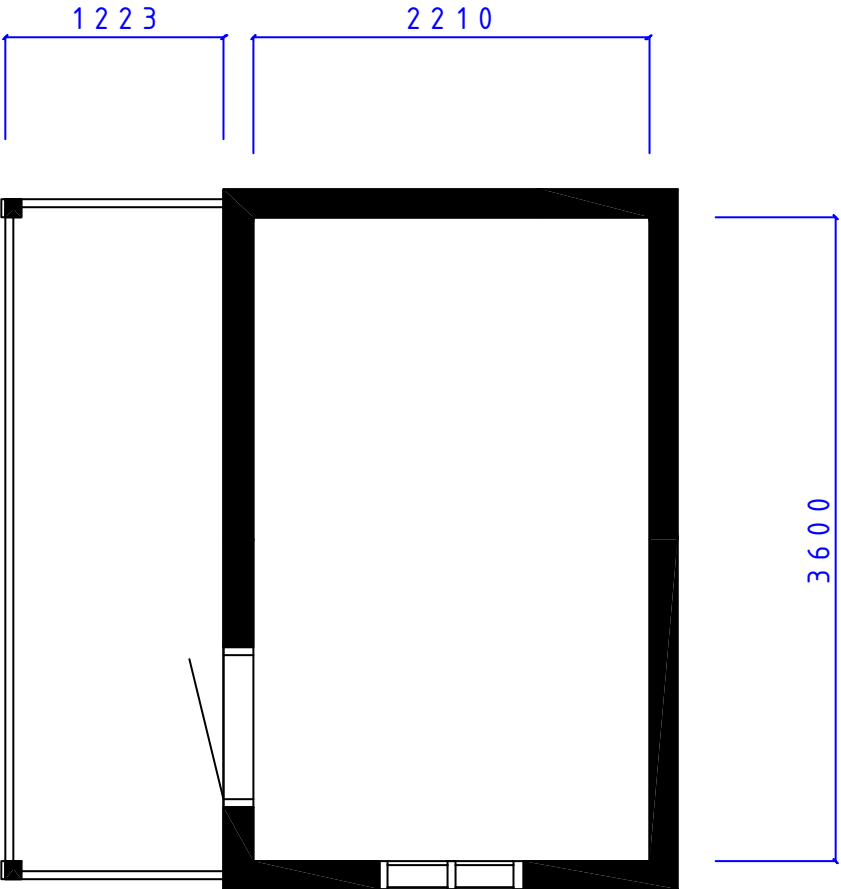

ÄNGA  
ÄNGA PLAN

SIZE	DATE	DWG. NO.	REV
	050206	05100242	