

REVISIONS				
ZONE	REV	DESCRIPTION	DATE	APPROVED

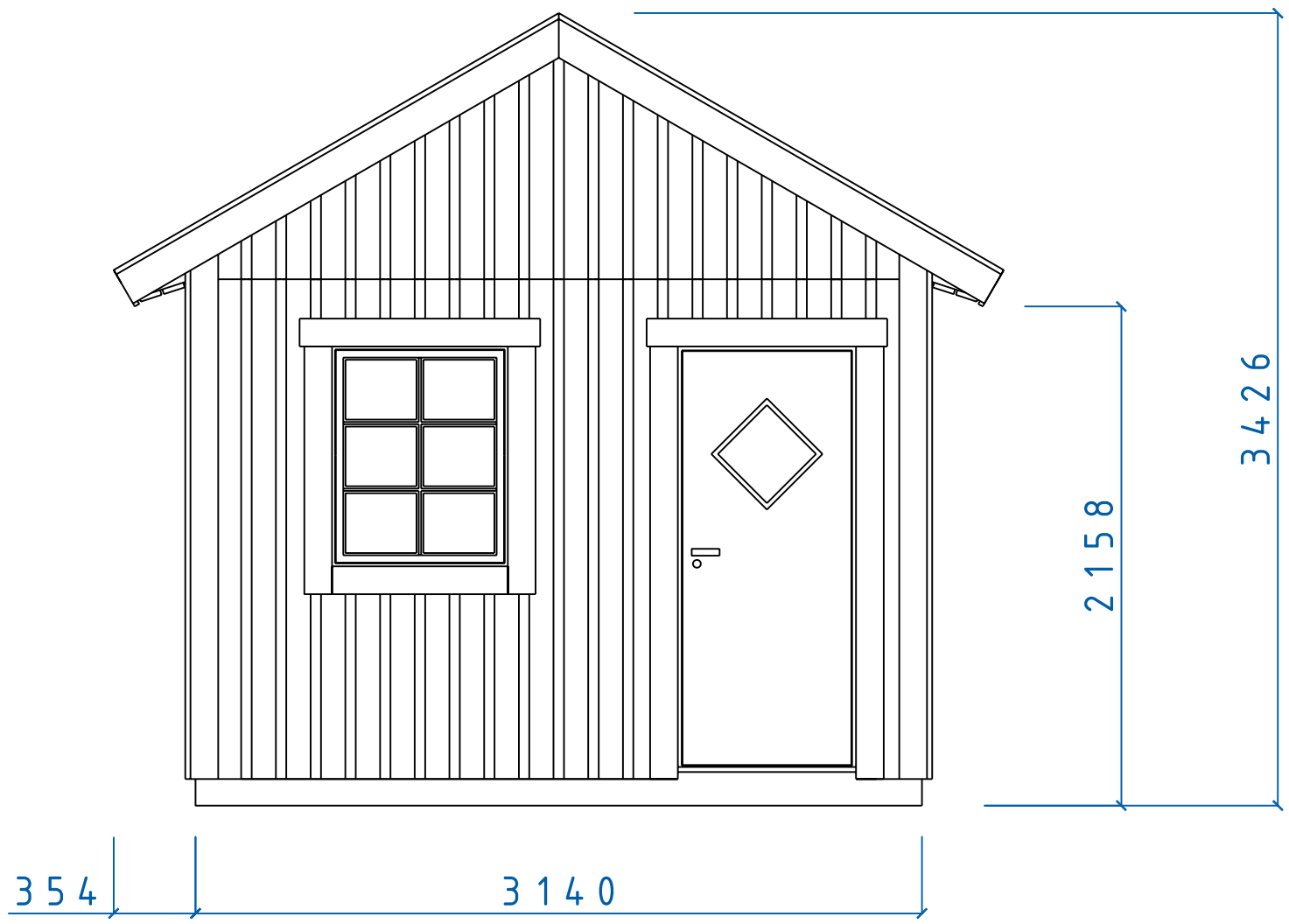

		MIDI SERIE	
		FASAD GAVEL F 8 x 10 D 8 x 19 TAK 30°	
SIZE	DATE	DWG NO.	REV
	060331	05100746	
Fiskaregatan 11 871 39 Rörörsåsa		www.caboden.se 0611-21790	Christer Arnborg Tele: 0705-984058
SCALE	Designed by: SMÅLÄNNING		SHEET

REVISIONS				
ZONE	REV	DESCRIPTION	DATE	APPROVED

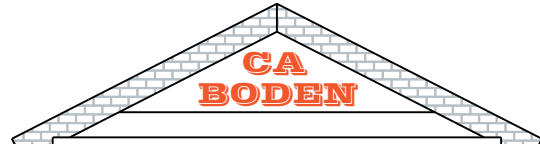
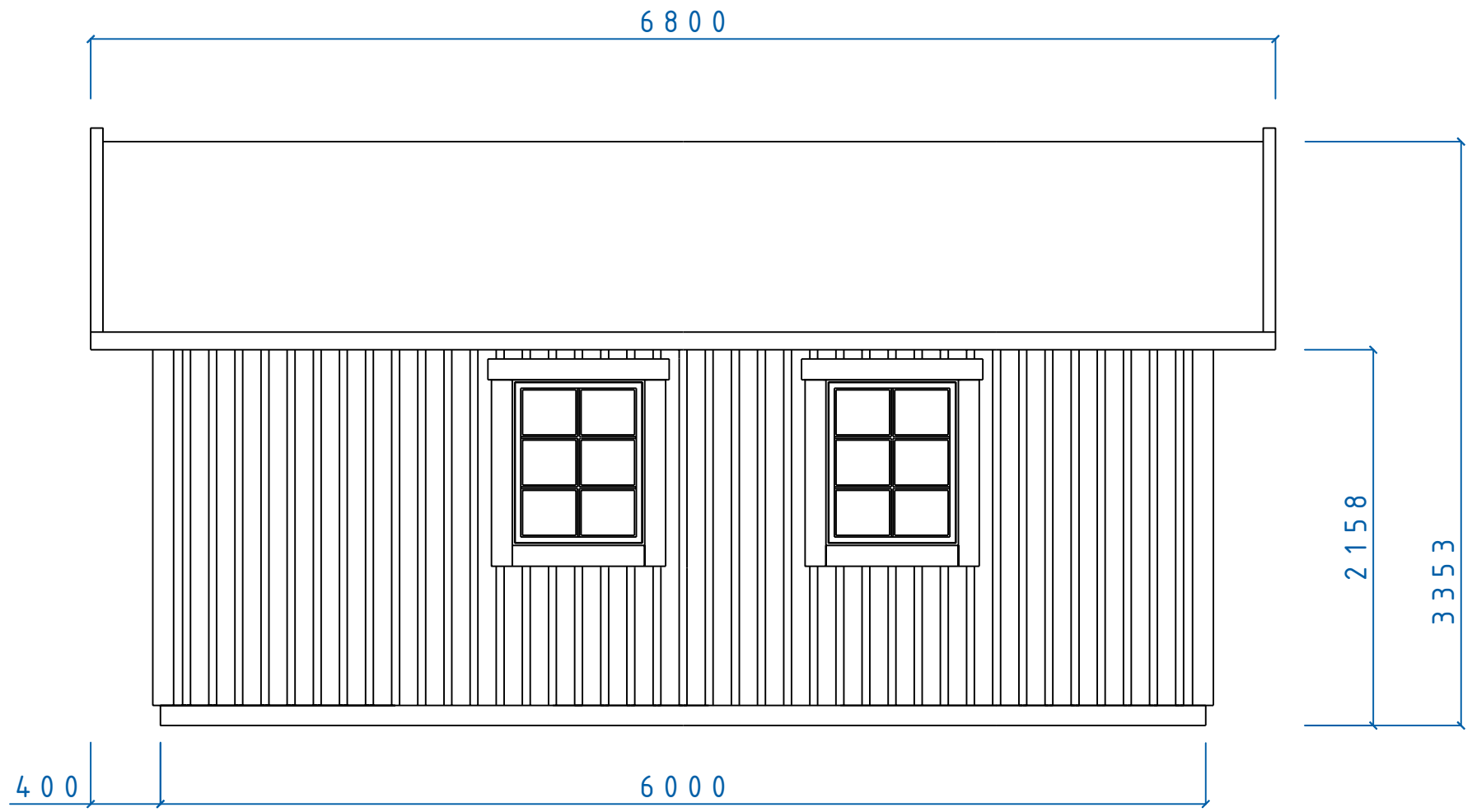

		MIDI SERIE		
		BIRKA		
		F8x10 D 8x19 TAK 30°		
SIZE	DATE	DWG NO.	REV	
	060331	05100747		
Fiskaregatan 11 871 39 Rörörsåsa		www.caboden.se 0611-21790	Christer Arnborg Tele: 0705-984050	
SCALE	Designed by: SMÅLÄNNING		SHEET	

REVISIONS				
ZONE	REV	DESCRIPTION	DATE	APPROVED

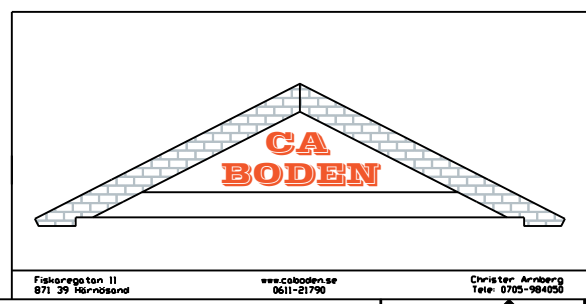
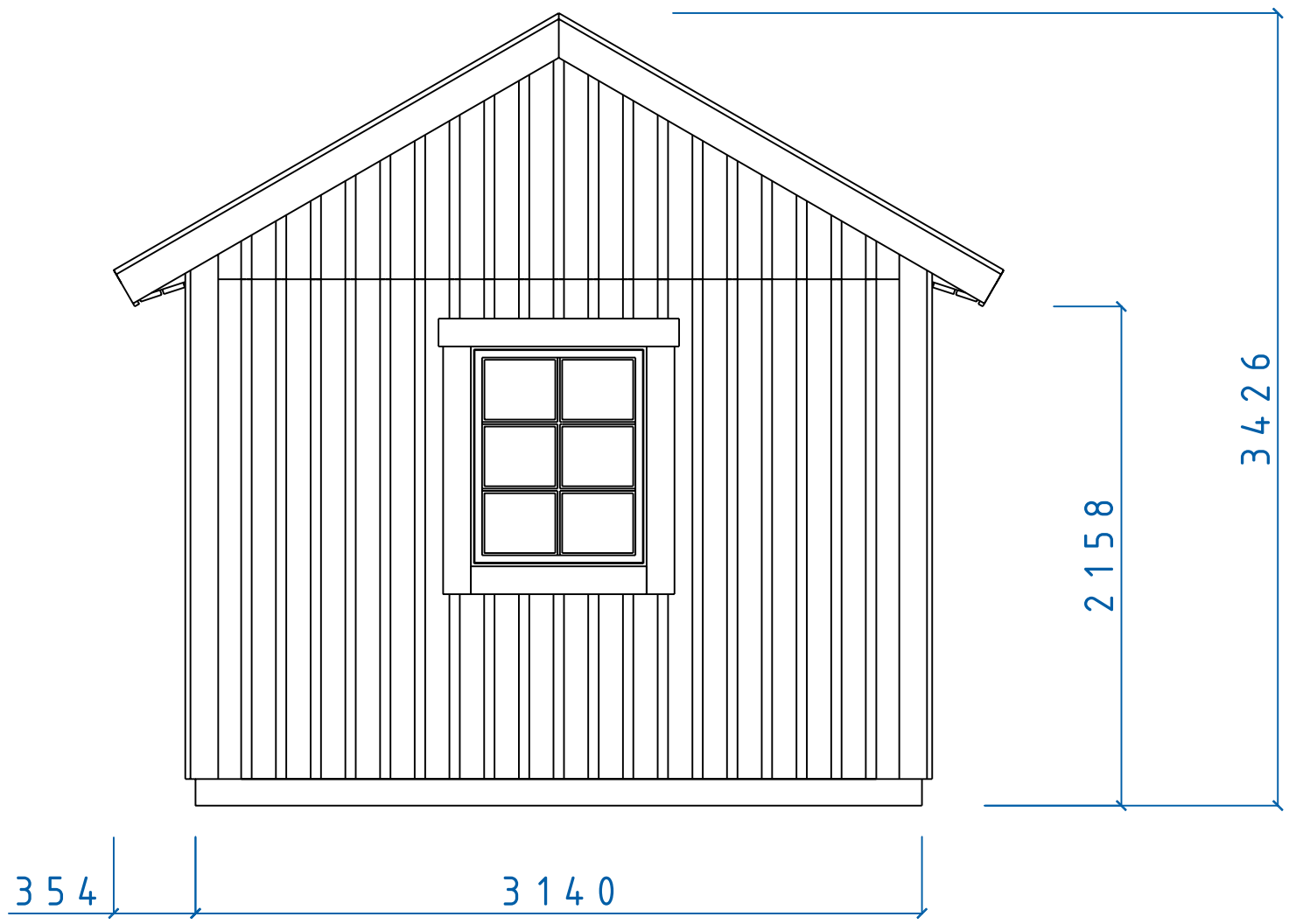

MIDI SERIE				
MIDI FASAD GAVEL F8x10				
SIZE	DATE	DWG NO.	REV	
	060214	05100552		
SCALE	Designed by: SMÅLÄNNING		SHEET	

Fiskaregatan 11  
871 39 Håröstrand

www.caboden.se  
0611-21790

Christer Arnborg  
Tele: 0705-984058

REVISIONS				
ZONE	REV	DESCRIPTION	DATE	APPROVED

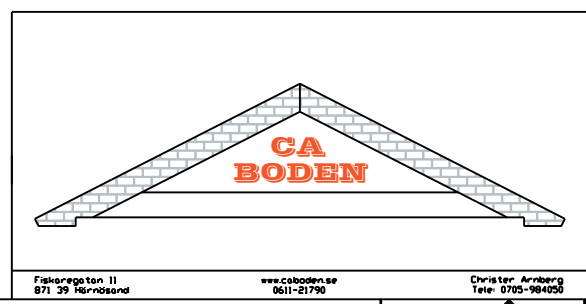
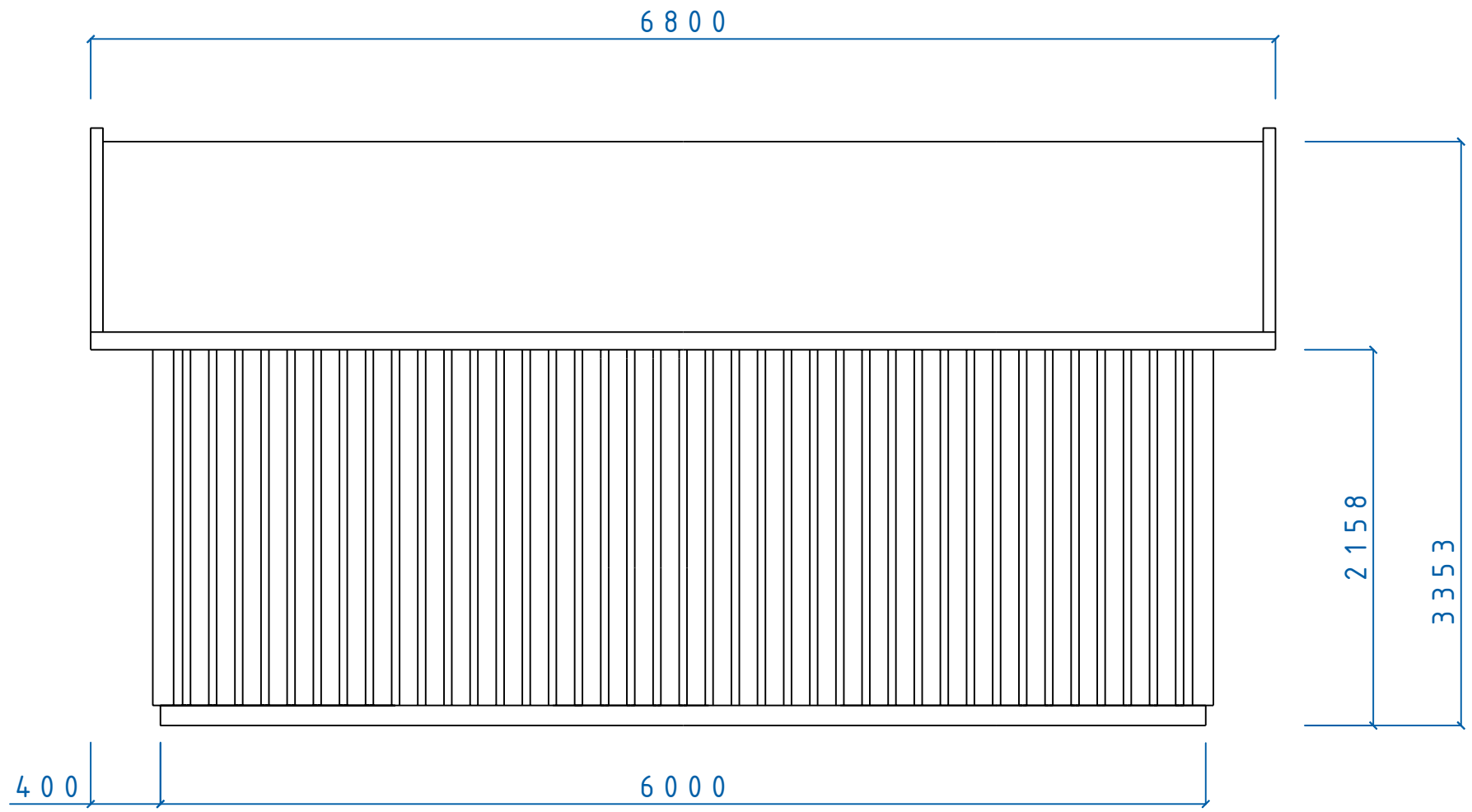

MIDI SERIE				
BIRKA FASAD SIDA				
SIZE	DATE	DWG NO.	REV	
	060214	05100547		
SCALE	Designed by: SMÅLÄNNING		SHEET	

REVISIONS				
ZONE	REV	DESCRIPTION	DATE	APPROVED

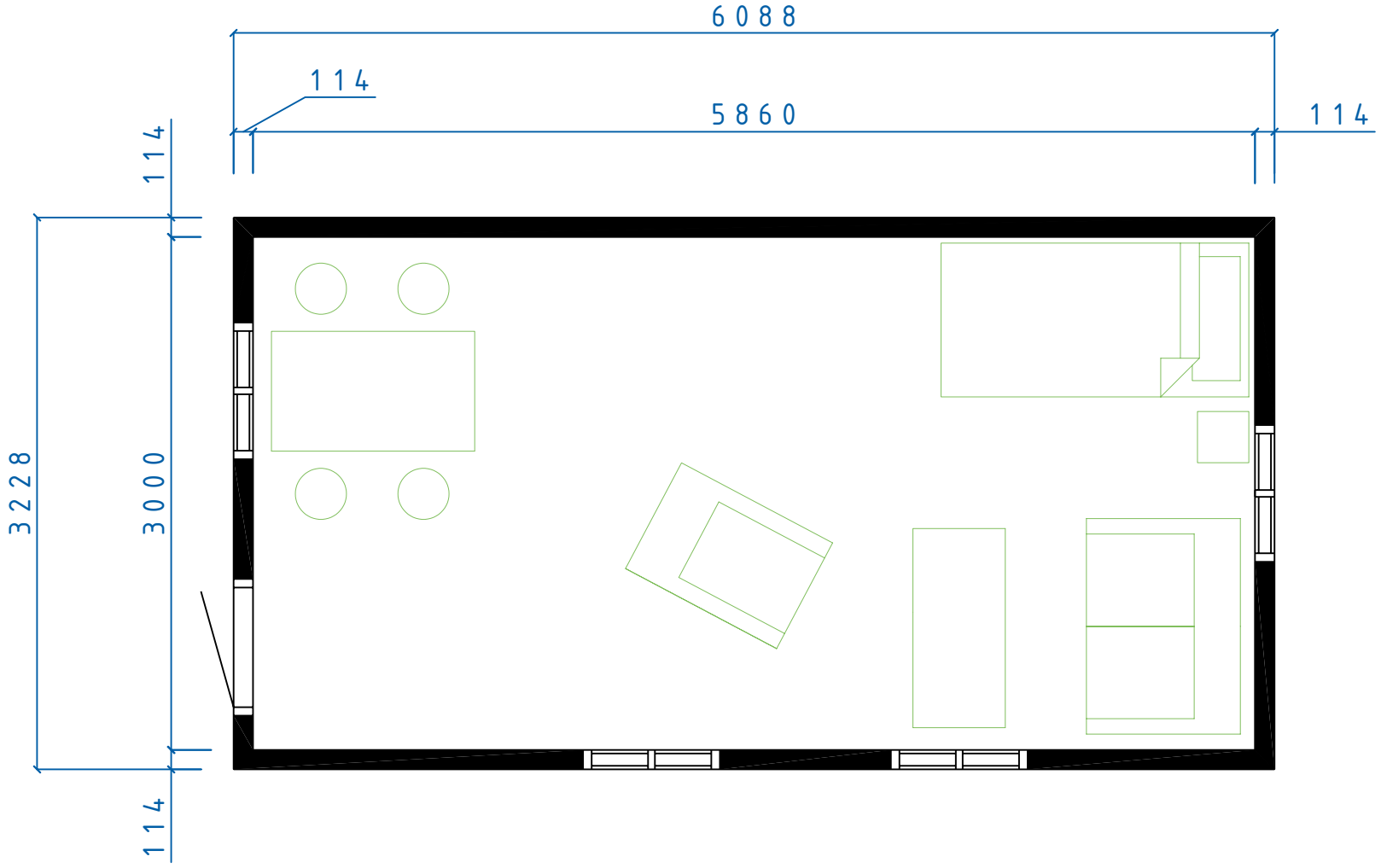

		MIDI SERIE		
		BIRKA PLANRITNING		
SIZE	DATE	DWG NO.	REV	
	060331	05100746		
SCALE	Designed by: SMÅLÄNNING		SHEET	

Fiskaregatan 11  
871 39 Hårnösand

www.cabodense.se  
0611-21790

Christen Arnborg  
Tele: 0705-984058

REVISIONS				
ZONE	REV	DESCRIPTION	DATE	APPROVED

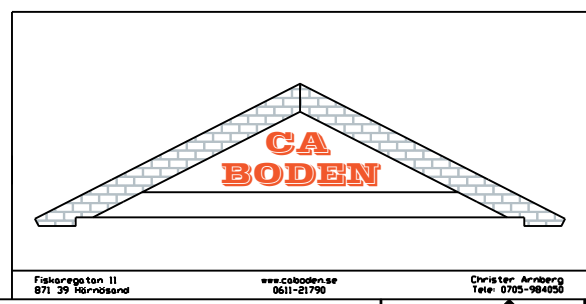
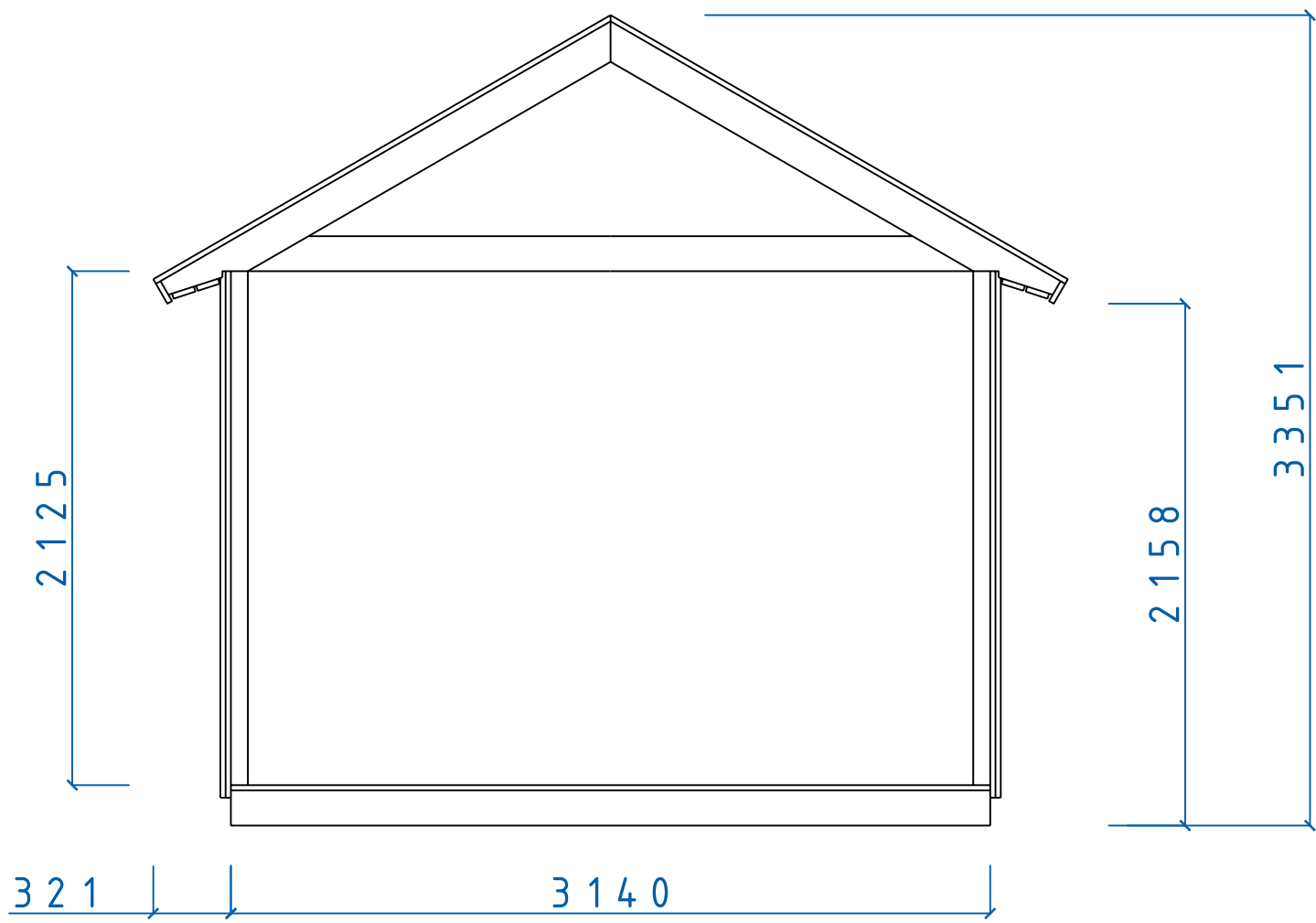

MIDI SERIE				
MIDI SEKTION				
SIZE	DATE	DWG NO.	REV	
	060214	05100546		
Fiskaregatan 11 871 39 Rörörsåsa		www.caboden.se 0611-21790		Christen Arberg Tele: 0705-984050
SCALE	Designed by: SMÅLÄNNING		SHEET	