

REVISIONS				
ZONE	REV	DESCRIPTION	DATE	APPROVED

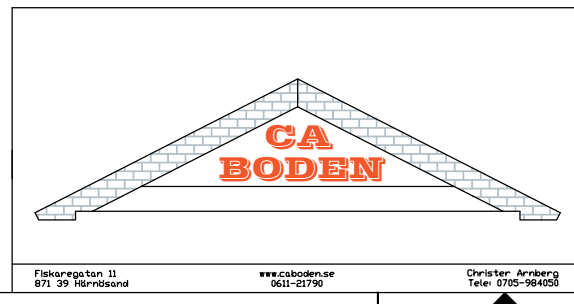

MINI SERIE				
FASAD GAVEL				
F8x8 D 8x19 TAK 30°				
SIZE	DATE	DWG NO.	REV	
	060330	05100732		
SCALE	Designed by: SMÅLÄNNING		SHEET	

REVISIONS				
ZONE	REV	DESCRIPTION	DATE	APPROVED

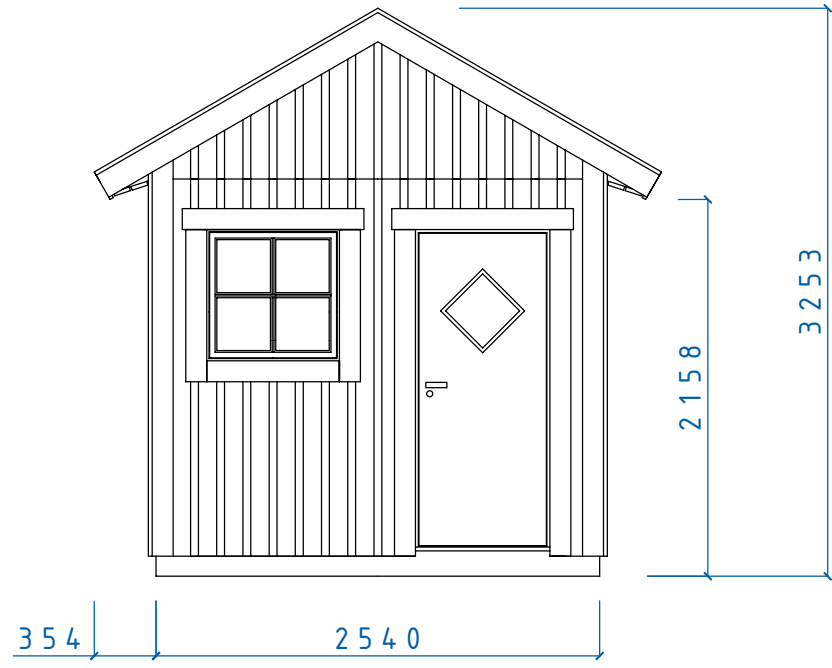
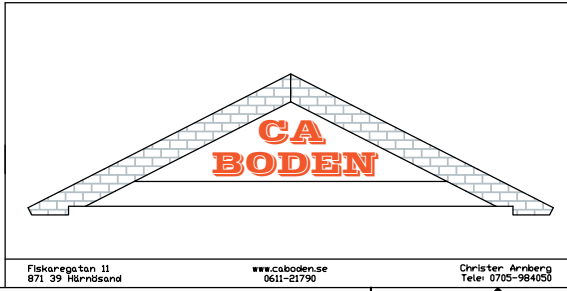
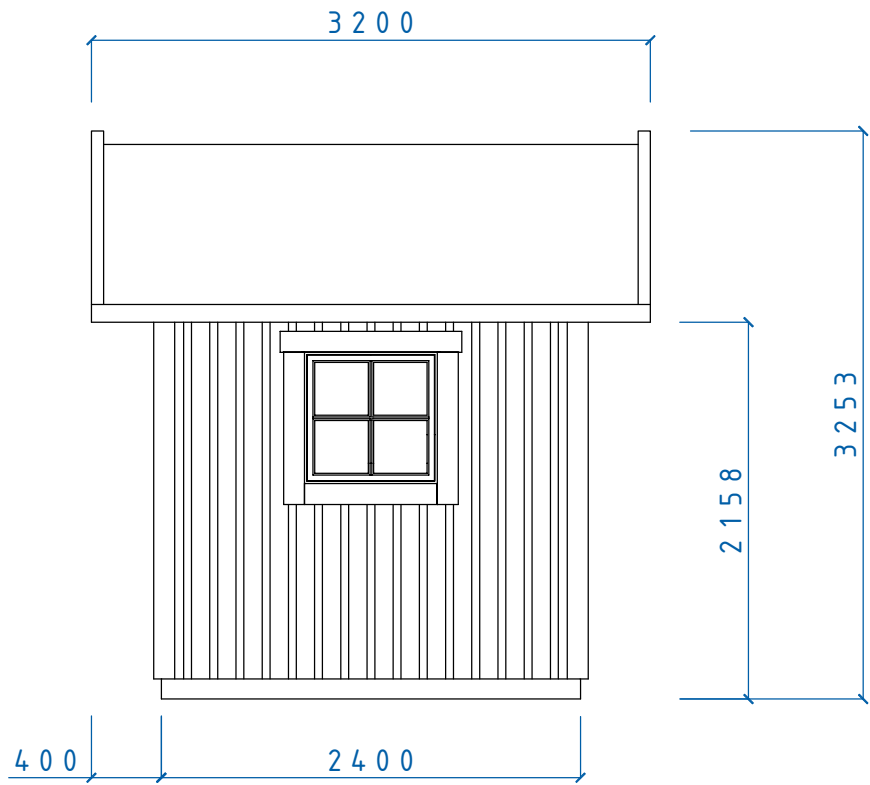

MINI SERIE				
BRÄNNÖ FASAD SIDA				
F 8X8 TAK 30°				
SIZE	DATE	DWG NO.	REV	
	060328	05100708		
SCALE	Designed by: SMÅLÄNNING		SHEET	

REVISIONS				
ZONE	REV	DESCRIPTION	DATE	APPROVED

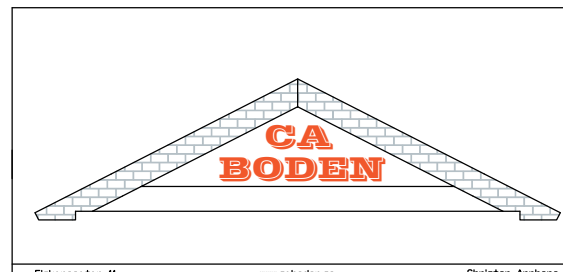
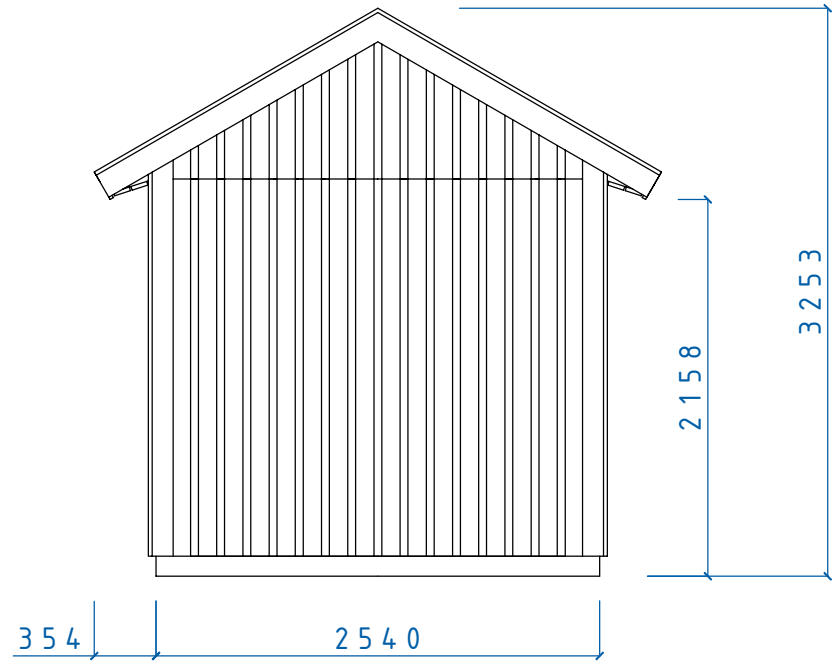

MINI SERIE				
FASAD GAVEL				
TAK 30°				
SIZE	DATE	DWG NO.	REV	
	060328	05100706		
SCALE	Designed by: SMÅLÄNNING		SHEET	

REVISIONS				
ZONE	REV	DESCRIPTION	DATE	APPROVED

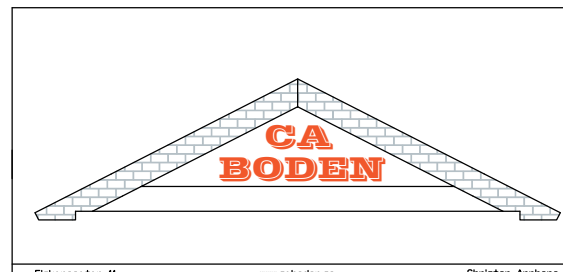
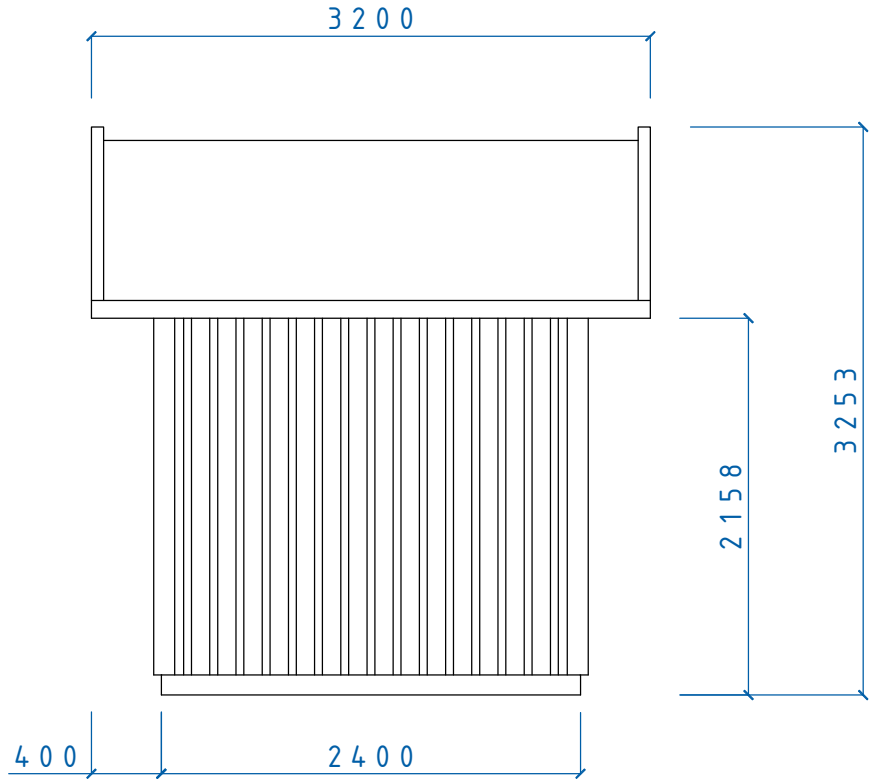

MINI SERIE			
BRÄNNÖ FASAD SIDA			
TAK 30°			
SIZE	DATE	DWG NO.	REV
	060328	05100707	
SCALE	Designed by: SMÅLÄNNING		SHEET

REVISIONS				
ZONE	REV	DESCRIPTION	DATE	APPROVED

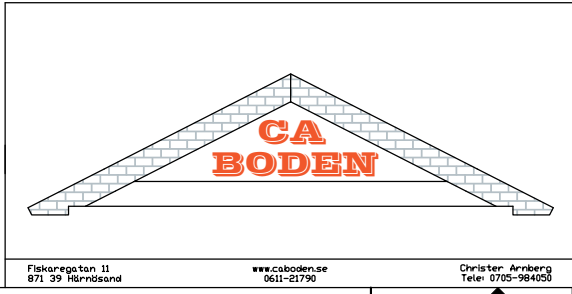
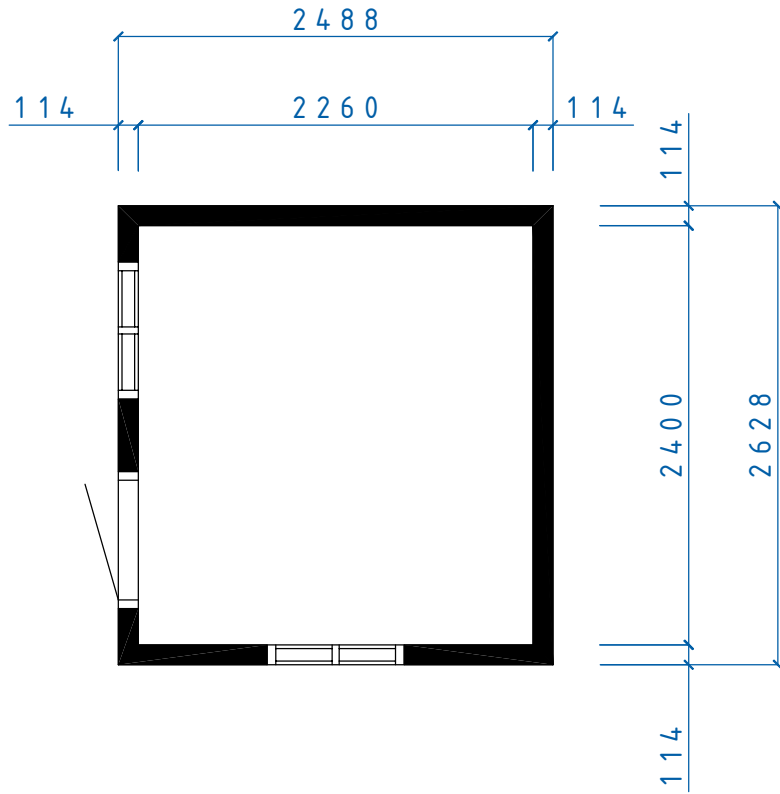

MINI SERIE			
BRÄNNÖ PLAN			
SIZE	DATE	DWG NO.	REV
	060329	05100710	
SCALE	Designed by: SMÅLÄNNING		SHEET

Fiskaregatan 11  
871 39 Härnösand

www.cabodense  
0611-21790

Christer Arnberg  
Tele: 0705-984050

REVISIONS				
ZONE	REV	DESCRIPTION	DATE	APPROVED

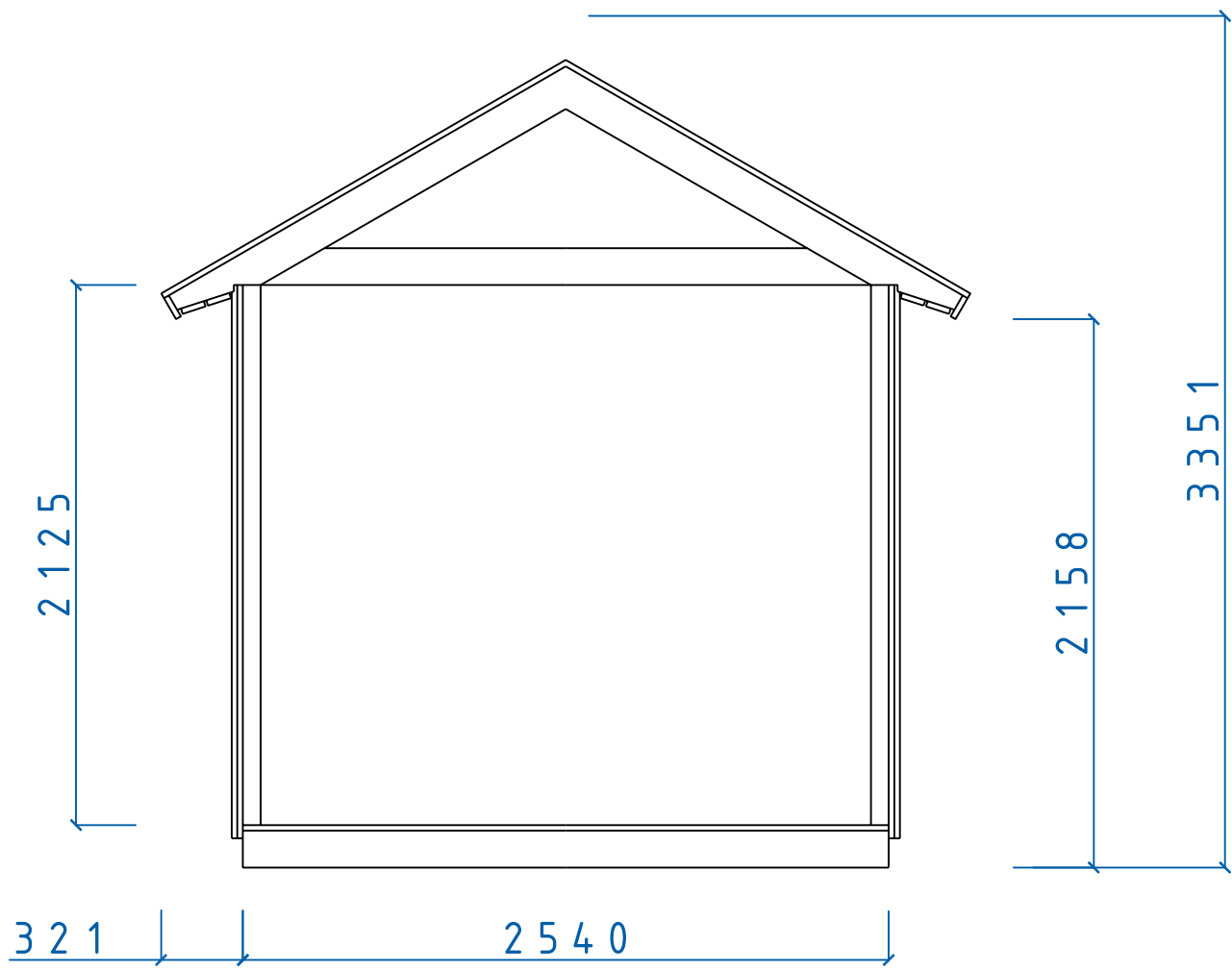

		MINI SERIE		
		MINI SEKTION		
SIZE	DATE	DWG NO.	REV	
	060329	05100726		
Fiskaregatan 11 871 39 Rörörsåsa		www.caboden.se 0611-21790		Christer Arnborg Tele: 0705-984050
SCALE	Designed by: SMÅLÄNNING		SHEET	